

Table of Contents

How to Compute Circular Mil Area of Various Wire Shapes 9003
 Terminal Stud Hole Size 9004

AMP Crimp Style

SOLISTRAND Uninsulated Terminals and Splices

Introduction 9005
 Terminals 9006, 9007
 Application Tooling 9008

STRATO-THERM Terminals and Splices for High Temperature Applications

Introduction 9009-9011
 Terminals and Splices 9012-9017
 PIDG Terminals and Splices for Thin Wall Cables 9018-9021
 Application Tooling 9022, 9023

COPALUM Sealed Terminals and Splices

Introduction 9024, 9025
 Terminals 9026, 9027
 Splices 9028
 Application Tooling 9029

PIDG (Pre-Insulated DIAMOND GRIP) Terminals and Splices

Introduction 9030
 Terminals 9031-9036
 Splices 9037
 Application Tooling 9045

Radiation Resistant/302°F [150°C] Pre-Insulated Terminals and Splices

Introduction 9038
 Terminals 9039
 Application Tooling 9040

AMPLI-BOND Insulated Terminals

Introduction 9041
 Terminals 9042
 Application Tooling 9045

TERMINYL Insulated Terminals

Introduction 9043
 Terminals 9044
 Application Tooling 9045

Raychem Solder & Crimp Style

Introduction 9046
 Typical Solder Sleeve Device/Installation 9046
 Product Selection 9047, 9048

Wire-to-Wire Splicing

Introduction 9049
 Solder Sleeve Wire Splices 9050-9055
 SolderGrip Closed End Connector Splices 9056-9061
 DuraSeal Heat-Shrinkable, Environmentally-Sealed,
 Nylon-Insulated Crimp Splices 9062, 9063
 MiniSeal High-Performance, Immersion-Resistant Crimp Splices 9064-9067

Insulated Terminals and Disconnects

Introduction 9068
 DuraSeal Heat-Shrinkable, Environmentally-Sealed,
 Nylon-Insulated Crimp Terminals and Disconnects 9069-9074
 SolderGrip Self-Fixturing Insulated Terminals 9075-9079

Wire Termination to Pin/Post/Tab

Introduction 9080
 SolderSleeve Discrete Wire Terminators 9081-9084

METRIC
 Dimensions in the
Raychem Solder &
 Crimp Style section are
 millimeters over inches. All
 others are inches over
 millimeters.

Terminals and Splices

Table of Contents (Continued)

Shield Termination

Introduction9085
SolderSleeve Shield Terminators9086-9091

Coaxial Cable Termination

Introduction9092
SolderSleeve Coaxial Cable Terminators9093, 9094
SolderSleeve PCB/Coaxial Cable Terminators9095, 9096

Cable-to-Cable Splicing

Introduction9097
SolderShield Sheilded and Coaxial Cable Splices9098-9101

Solder Style Application Tooling9102-9109
---	------------

How to Compute Circular Mil Area of Various Wire Shapes

Square or Rectangular Wire

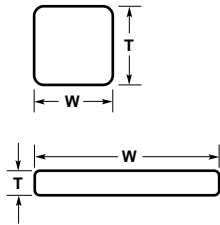

U.S. Customary Dimensions

Multiply the width of the wire cross section in mils by the thickness of the wire cross section in mils by 1.2732 and subtract the radius factor shown below.

$$CMA = W \times T \times 1.2732 - \text{radius factor}$$

Metric Dimensions

Multiply the width of the wire cross section in millimeters by the thickness of the wire cross section in millimeters by 1973.525 and subtract the radius factor shown below.

$$CMA = W \times T \times 1973.525 - \text{radius factor}$$

Round Solid Wire AWG



Multiply the diameter in mils by itself.

$$CMA = D^2$$

Multiply the diameter in millimeters by itself by 1550.003

$$CMA = D^2 \times 1550.003$$

Stranded Wire AWG

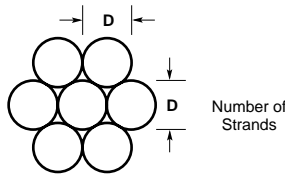

Multiply the diameter of one strand (in mils) by itself, and then multiply the result by the total number of strands.

$$CMA = D^2 \times N$$

Multiply the diameter of one strand in millimeters by itself by the number of strands by 1550.003.

$$CMA = D^2 \times N \times 1550.003$$

Conversion Table

To Convert From	To	Multiply By
CMA	mm ²	.0005067075
CMA	in ²	.0000007854
mm ²	in ²	.001550003
mm ²	CMA	1973.525

Note: Refer to table listing for circular mil area for common wire sizes.

Radius Factor, U.S. Customary

Radius (in.)	Radius Factor To Subtract (CMA)
.010	110
.012	158
.016	280
.020	438
.026	740
.032	1121
.040	1752
.063	4346
.094	9675

Radius must be measured.

Radius Factor, Metric

Radius (mm)	Radius Factor To Subtract (CMA)
0.25	106
0.3	153
0.35	208
0.4	272
0.5	424
0.6	611
0.8	1086
1.2	2444

Radius must be measured.

Cross Reference AMP Closed Barrel Sizes/Metric Cable

Wire Size in ² [mm ²]	Typical cables (metric)	AMP Code
.00078 [0.5]	16/0.20	22-16
.00116 [0.75]	24/0.20	22-16
.00155 [1.0]	32/0.20	1/1.13 22-16
.00233 [1.5]	30/0.25	1/1.38 22-16, 16-14
.00388 [2.5]	50/0.25	1/1.78 16-14
.00620 [4.0]	56/0.30	7/0.85 12-10
.00930 [6.0]	84/0.30	7/1.04 12-10
.01550 [10]	80/0.40	7/1.35 8
.02480 [16]	126/0.40	7/1.70 6
.03875 [25]	196/0.40	7/2.14 4
.05425 [35]	276/0.40	19/1.53 2
.07750 [50]	396/0.40	19/1.78 1/0
.10850 [70]	360/0.50	19/2.14 2/0
.14725 [95]	475/0.50	19/2.52 3/0
.18600 [120]	608/0.50	37/2.93 231-300 MCM
.23250 [150]	756/0.50	37/2.25 231-300 MCM
.28675 [185]	925/0.50	37/2.52 300-380 MCM
.37200 [240]	1221/0.50	61/2.25 380-478 MCM

Cross Reference AMP Closed Barrel Sizes/Metric Aircraft Cables



















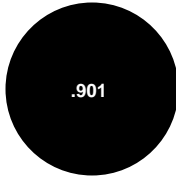

Wire Size in ² [mm ²]	Typical cables (metric)	AMP Code
.00023 [0.15]	19/0.10	26-22
.00033 [0.21]	19/0.12 7/0.20	26-22, 24-22
.00053 [0.34]	19/0.15	24-22
.00093 [0.60]	19/0.20	22-16, 20
.00144 [0.93]	19/0.25	22-16, 18-16
.00207 [1.34]	19/0.30	16-14, 18-16
.00282 [1.82]	37/0.25	16-14, 18-16
.00465 [3.00]	37/0.32 19/0.45	12-10, 14-12
.00721 [4.65]	37/0.40	12-10
.01304 [8.41]	119/0.30	8
.01993 [12.86]	182/0.30	6
.03221 [20.78]	294/0.30	4
.05005 [32.29]	203/0.45	2
.06040 [38.97]	245/0.45 (Size 1)	2
.07938 [51.21]	322/0.45	1/0
.10354 [66.80]	420/0.45	2/0
.12769 [82.38]	518/0.45	3/0
.16393 [105.76]	665/0.45	4/0

Use to Select Proper Size Terminal

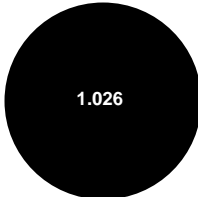
The chart shows sizes and dimensions of various studs and the corresponding terminal stud hole sizes used with AMP devices.

For example, with stud #5 (.125 [3.18] Diameter), use AMP device listed for #5 stud (.129 [3.28] Hole Diameter).

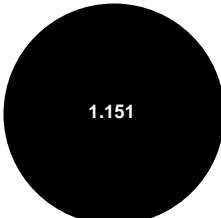
Terminal stud hole sizes may easily be checked by fitting sample terminal to black circle. Chart shows cross reference from BA-US-Metric stud sizes.

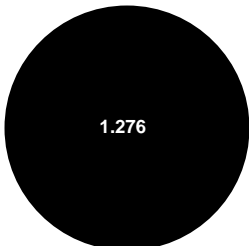
Stud Size			Stud Dia.	Minimum Terminal Hole Diameter	Stud Size		Stud Dia.	Minimum Terminal Hole Diameter	
Imperial	U.S. Cust.	Metric			U.S. Cust.	Metric			
	#0		.060		.064				
	#1		.073		.077	5/8"	M16	.625	
	#2	M2	.086		.090				
8BA	#3		.099		.103				
6BA	#4	M2.5	.112		.116	3/4"		.750	
	#5	M3	.125		.129				
4BA	#6	M3.5	.138		.142				
	#8	M4	.164		.168	7/8"	M22	.875	
2BA	#10		.190		.194				
	#12		.216		.220				
	#14		.242		.245	1"		1.000	
0BA	1/4"	M6	.250		.260				
	5/16"	M8	.312		.323				
	3/8"	M9.5	.375		.385	1 1/8"		1.125	
	7/16"		.437		.448				
	1/2"	M12	.500		.510	1 1/4"		1.250	

Introduction

SOLISTRAND terminals and splices are specially designed to terminate solid and stranded wire, irregular shaped conductors, and combinations of these — still retaining the superior performance characteristics of single-purpose terminals and splices. Because we match the terminal to the tool each termination is uniform, making quality control easy and performance consistent. Corrosion resistance, vibration resistance and tensile strength of these terminals and splices are well within the limits of commercial and military specifications. The SOLISTRAND terminals and splice line includes parallel and butt splices, and flag, ring, spade, hooked, and flanged tongue terminals in sizes from 26 AWG [0.1 mm²] through 600 MCM [304 mm²].

The Crimp

The "W" Crimp is one of several time-proven crimp types developed by Tyco Electronics. It is not just a "kink" in a metal barrel; not something pinched over electrical wire ends. The "W" Crimp is actually two longitudinal crimps applied with precisely controlled pressure so that the conductor within the barrel flows together into the dimples or serrations of the terminal barrel creating one homogeneous mass of metal. The two indents also help to center conductors within the barrel for uniform crimping of the barrel around the wire. Furthermore, the "W" Crimp permits the use of a shorter terminal barrel, an excellent feature for confined area termination.

The "W" Crimp creates terminations of optimum electrical properties and is completely reliable, giving long service in harsh environments.

"W" Crimp

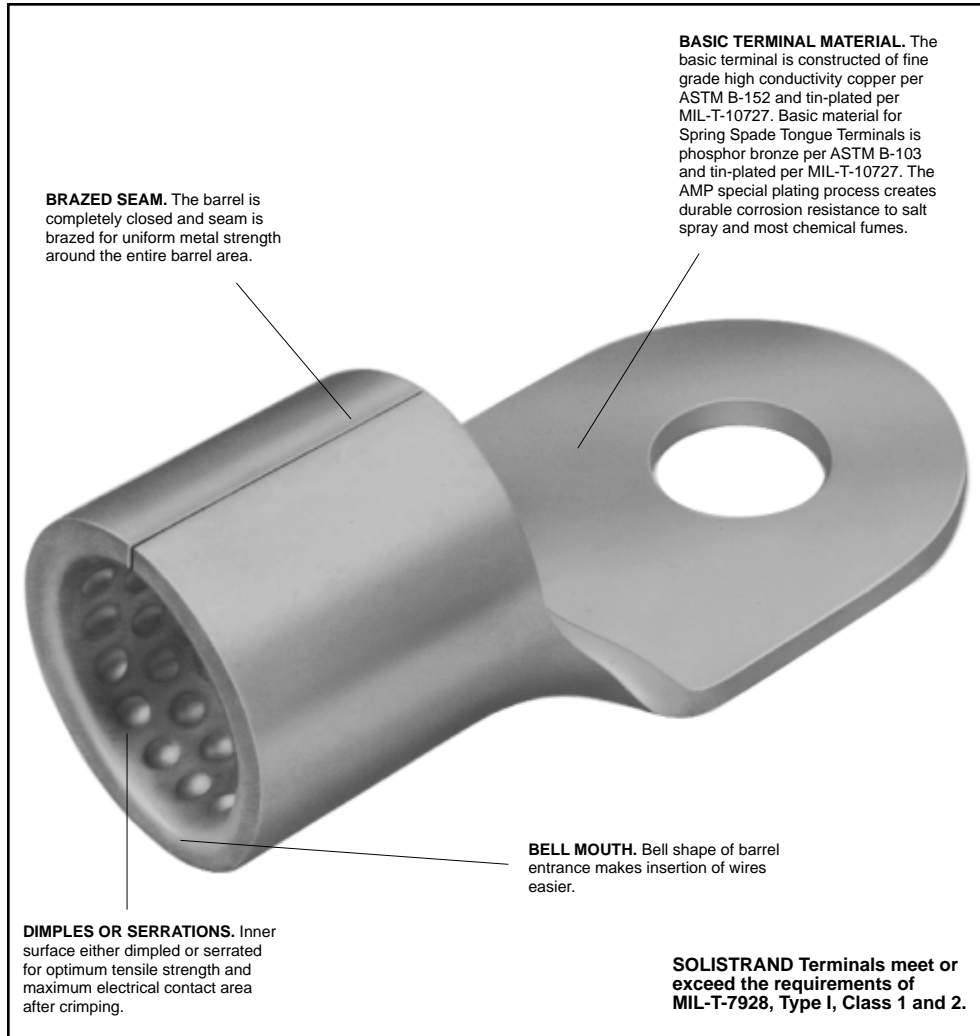
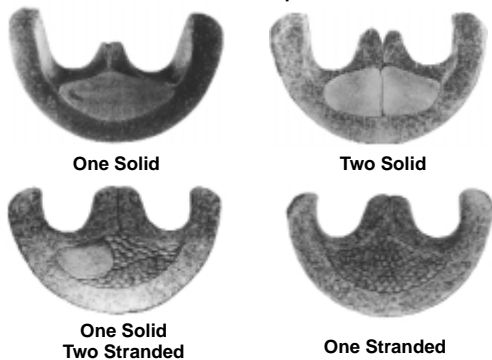

BASIC TERMINAL MATERIAL. The basic terminal is constructed of fine grade high conductivity copper per ASTM B-152 and tin-plated per MIL-T-10727. Basic material for Spring Spade Tongue Terminals is phosphor bronze per ASTM B-103 and tin-plated per MIL-T-10727. The AMP special plating process creates durable corrosion resistance to salt spray and most chemical fumes.

Temperature Rating: 338°F [170°C] Max.

AMP SOLISTRAND Terminals and Splices (Use SOLISTRAND Tooling)

AMP Wire Size	UL Listed File No. E13288	SP® LR 7189 Certified
22-16 Solid or Stranded	22-16 Solid or Stranded	22-16 Solid or Stranded
16-14 Solid or Stranded	16-14 Solid or Stranded	16-14 Solid or Stranded
16-14 Heavy Duty Solid or Stranded	16-14 Heavy Duty Stranded	16-14 Heavy Duty Solid or Stranded
14-12 Solid or Stranded	14-12 Stranded	14-12 Solid or Stranded
12-10 Solid or Stranded	12-10 Stranded	12-10 Solid or Stranded
8 thru 600 MCM Solid or Stranded	8 thru 600 MCM Stranded	8 thru 600 MCM Solid or Stranded

Note: 22-16 terminals and splices are stamped 22-18 in accordance with MIL-T-7928. Commercial wire range is 22-16.

Material and Finish:

Terminal Body — Copper per ASTM B-152

Plating — Tin per MIL-T-10727

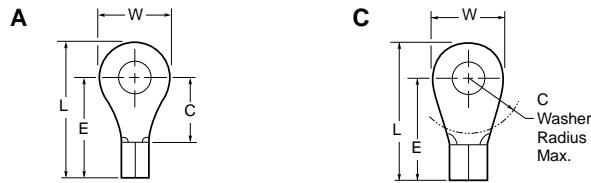

Military Specification M7928/7

Wire Size Circular Mils [mm ²]	Stud Size	Style	Dimensions				Material Thickness Max.	Wire Barrel I.D. Min.	Class	M7928/7 Dash Number	Part Number
			L Max.	E Max.	C Min.	W					
22-16 509-3,260 [0.26-1.65]	2 M2	A	.449 11.40	.337 8.56	.156 3.96	.218 5.54	.033 0.84	.061 1.55	2	1	34103 2-34103-1
	4	A	.449 11.40	.337 8.56	.156 3.96	.218 5.54	.033 0.84	.061 1.55	2	2	34104* 2-34104-6
	6 M3.5	A	.621 15.77	.462 11.73	.281 7.14	.312 7.92	.033 0.84	.061 1.55	2	3	34110* 2-34110-3
	10	A	.621 15.77	.462 11.73	.281 7.14	.312 7.92	.033 0.84	.061 1.55	2	4	34112* 2-34112-2
	5/16 M8	A	.856 21.74	.618 15.70	.437 11.10	.469 11.91	.033 0.84	.061 1.55	2	5	34114* 2-34114-2
	3/8	A	.995 25.27	.727 18.47	.546 13.87	.531 13.49	.033 0.84	.061 1.55	2	6	34115* 2-34115-2
16-14 2,050-5,180 [1.04-2.62]	4	A	.480 12.19	.352 8.94	.171 4.34	.250 6.35	.033 0.84	.085 2.16	2	11	34119* 2-34119-1
	6 M3.5	A	.590 14.99	.431 10.95	.250 6.35	.312 7.92	.033 0.84	.085 2.16	2	7	321684* 2-321684-1
	10	A	.669 16.99	.510 12.95	.250 6.35	.312 7.92	.033 0.84	.085 2.16	1 & 2	8	320093 2-320093-1
	5/16 M8	A	.855 21.72	.618 15.70	.437 11.10	.469 11.91	.033 0.84	.085 2.16	2	9	34125* 2-34125-6
	3/8	A	.995 25.27	.727 18.47	.546 13.87	.531 13.49	.033 0.84	.085 2.16	2	10	34126* 2-34126-2

Note: Part numbers are shown as loose piece over tape mounted product.
* Part numbers are available in small quantity packages.

Military Specification MS20659

Wire Size Circular Mils [mm ²]	Stud Size	Style	Dimensions				Material Thickness Max.	Wire Barrel I.D. Min.	Class	MS20659 Dash Number	Part Number
			L Max.	E Max.	C	W					
12-10 5,180-13,100 [2.62-6.64]	6 M3.5	A	.630 16.00	.487 12.37	.219 5.56	.281 7.14	.042 1.07	.129 3.28	2	165	35476* 2-35476-1
	10	A	.765 19.43	.575 14.61	.302 7.67	.375 9.53	.042 1.07	.129 3.28	1 & 2 2	105	33457* 2-33457-2
	5/16 M8	A	1.004 25.50	.736 18.69	.468 11.89	.531 13.49	.042 1.07	.129 3.28	1 & 2 2	106	33459* 2-33459-6
	3/8	A	1.098 27.89	.799 20.29	.531 13.49	.593 15.06	.042 1.07	.129 3.28	1 & 2	128	33220*
	1/2 M12	A	1.271 32.28	.893 22.68	.625 15.88	.750 19.05	.042 1.07	.129 3.28	2	166	35135
8 13,100-20,800 [6.64-10.5]	8 M4	C	.949 24.10	.743 18.87	.359 9.12	.406 10.31	.051 1.30	.172 4.37	2	140	324061*
	10	C	.949 24.10	.743 18.87	.359 9.12	.406 10.31	0.51 1.30	.172 4.37	2	107	31807 2-31807-2* ²
	1/4 M6	C	.933 23.70	.696 17.68	.359 9.12	.469 11.91	.051 1.30	.172 4.37	2	141	33461* 2-33461-2* ¹
	5/16 M8	A	1.074 27.28	.790 20.07	.406 10.31	.562 14.27	.051 1.30	.172 4.37	2	108	31808*
	3/8	A	1.168 29.67	.868 22.05	.531 13.49	.594 15.09	.051 1.30	.172 4.37	2	129	33463*
6 20,800-33,100 [10.5-16.8]	10	C	1.168 29.67	.931 23.65	.531 13.49	.468 11.89	.060 1.52	.232 5.89	2	130	321298*
	1/4 M6	C	1.168 29.67	.931 23.65	.531 13.49	.468 11.89	.060 1.52	.232 5.89	2	109	321598*
	5/16 M8	C	1.246 31.65	.931 23.65	.531 13.49	.625 15.88	.060 1.52	.232 5.89	2	131	33466* 2-33466-3
	3/8	C	1.246 31.65	.931 23.65	.531 13.49	.625 15.88	.060 1.52	.232 5.89	2	110	33467*
	1/2 M12	C	1.840 46.74	1.400 35.56	1.000 25.40	.875 22.23	.060 1.52	.232 5.89	2	143	320344*

Note: Part numbers are shown as loose piece over tape mounted product.
* Part numbers are available in small quantity packages.
¹ Requires a 69875 standard AMP-TAPETRONIC machine for application.
² Requires a 68250-1 Heavy Duty AMP-TAPETRONIC machine for application.

Ring Tongue Terminals (Continued)

Material and Finish:

Terminal Body — Copper per ASTM B-152

Plating — Tin per MIL-T-10727

Military Specification

MS20659 (Continued)

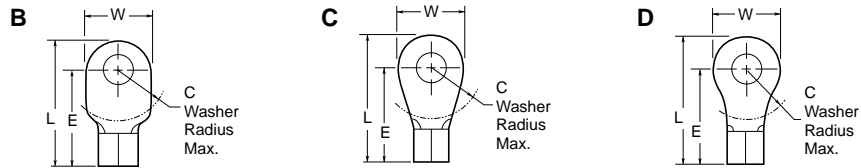

Wire Size Circular Mils [mm ²]	Stud Size	Style	Dimensions				Material Thickness Max.	Wire Barrel I.D. Min.	Class	MS20659 Dash Number	Part Number
			L Max.	E Max.	C	W					
4 33,100–52,600 [16.8–26.7]	10	C	1.199 30.45	.946 24.03	.437 11.10	.500 12.70	.073 1.85	.280 7.11	2	144	33114
	1/4 M6	C	1.199 30.45	.946 24.03	.437 11.10	.500 12.70	.073 1.85	.280 7.11	2	111	31811*
	5/16 M8	C	1.324 33.63	1.009 25.63	.500 12.70	.625 15.88	.073 1.85	.280 7.11	2	132	33115
	3/8	C	1.324 33.63	1.009 25.63	.500 12.70	.625 15.88	.073 1.85	.280 7.11	2	112	31812
	1/2 M12	B	1.902 48.31	1.462 37.13	1.000 25.40	.875 22.23	.073 1.85	.296 7.52	2	145	327175*
2 52,600–83,700 [26.7–42.4]	10	B	1.527 38.79	1.212 30.78	.531 13.49	.625 15.88	.073 1.85	.370 9.40	2	146	330301
	1/4 M6	B	1.527 38.79	1.212 30.78	.531 13.49	.625 15.88	.073 1.85	.370 9.40	2	113	320383*
	5/16 M8	B	1.527 38.79	1.212 30.78	.531 13.49	.625 15.88	.073 1.85	.370 9.40	2	147	322870*
	3/8	B	1.527 38.79	1.212 30.78	.531 13.49	.625 15.88	.073 1.85	.370 9.40	2	114	321600*
	7/16	D	1.657 42.09	1.212 30.78	.531 13.49	.890 22.61	.073 1.85	.370 9.40	2	148	320741
1/0 83,700–119,500 [42.4–60.6]	1/4 M6	C	1.925 48.90	1.532 38.91	.625 15.88	.807 20.50	.073 1.85	.444 11.28	2	117	321866
	5/16 M8	C	1.925 48.90	1.532 38.91	.625 15.88	.807 20.50	.073 1.85	.444 11.28	2	151	321867*
	3/8	C	1.925 48.90	1.532 38.91	.625 15.88	.807 20.50	.073 1.85	.444 11.28	2	118	321868
	7/16	C	1.956 49.68	1.529 38.84	.625 15.88	.875 22.23	.073 1.85	.444 11.28	2	152	36918
	1/2 M12	C	1.956 49.68	1.529 38.84	.625 15.88	.875 22.23	.073 1.85	.444 11.28	2	135	36919*
2/0 119,500–150,500 [60.6–76.3]	1/4 M6	C	1.930 49.02	1.550 39.37	.625 15.88	.926 23.52	.083 2.11	.504 12.80	2	153	321869
	5/16 M8	C	1.930 49.02	1.550 39.37	.625 15.88	.926 23.52	.083 2.11	.504 12.80	2	119	321870*
	3/8	C	1.930 49.02	1.550 39.37	.625 15.88	.926 23.52	.083 2.11	.504 12.80	2	120	321871*
	7/16	C	1.930 49.02	1.550 39.37	.625 15.88	.926 23.52	.083 2.11	.504 12.80	2	154	321872
	1/2 M12	C	1.930 49.02	1.550 39.37	.625 15.88	.926 23.52	.083 2.11	.504 12.80	2	136	321873*
3/0 150,500–190,000 [76.3–96.3]	5/16 M8	B	2.112 53.64	1.622 41.20	.625 15.88	1.020 25.91	.094 2.39	.565 14.35	2	155	321874
	3/8	B	2.112 53.64	1.622 41.20	.625 15.88	1.020 25.91	.094 2.39	.565 14.35	2	121	321875*
	7/16	B	2.112 53.64	1.622 41.20	.625 15.88	1.020 25.91	.094 2.39	.565 14.35	2	156	321876
	1/2 M12	B	2.112 53.64	1.622 41.20	.625 15.88	1.020 25.91	.094 2.39	.565 14.35	2	122	321877*
	5/16 M8	B	2.537 64.44	1.985 50.42	1.078 27.38	1.150 29.21	.105 2.67	.635 16.13	2	157	321271
4/0 190,000–231,000 [96.3–117]	3/8	B	2.178 55.32	1.657 42.09	.625 15.88	1.087 27.61	.105 2.67	.635 16.13	2	123	321878*
	7/16	B	2.178 55.32	1.657 42.09	.625 15.88	1.087 27.61	.105 2.67	.635 16.13	2	158	321879
	1/2 M12	B	2.178 55.32	1.657 42.09	.625 15.88	1.087 27.61	.105 2.67	.635 16.13	2	124	321880*
	5/8 M16	B	2.206 56.03	1.644 41.76	.625 15.88	1.150 29.21	.105 2.67	.635 16.13	2	159	36935
	3/4	C	2.732 69.39	2.117 53.77	1.078 27.38	1.275 32.39	.105 2.67	.635 16.13	2	160	322228
7/8 M22	C	2.732 69.39	2.117 53.77	1.078 27.38	1.275 32.39	.105 2.67	.635 16.13	2	137	321625	

* Part numbers are available in small quantity packages.

Wire Size Range
AWG 26 to 6

Product Type	AMP Wire Size	Hand Tools	Pneumatic Tooling		Dies for 6-26, Tool 189721-1 Requires Straight Action Adapter 217200-1 or 318161-1 Dies Also Fit 69710-1 Hand Tool	Tooling For Tape Mounted Products
			Crimping Heads for 6-26, Tool 189721-1			Dies for 69875 AMP-TAPETRONIC AMP-O-LECTRIC Requires Applicator AMPOMATOR CLS IV Requires Applicators
			Single Wire Range	Multiple Wire Range		
SOLISTRAND terminals	26-22	69363 ²	—	—	—	768625-1
	24-20		—	—	—	—
	22-16	49935 ²	314516-1	—	47812, 314925-1 ⁴	68240-1
	16-14		314517-1	679301-1	47813, 314926-1 ⁴	68241-1
	12-10 & 16-14 HD	58546-1 ³	—	—	47814 ⁴	68242-1
	14-12	49592 ²	314518-1	—	—	90566-1
	8	—	1338757-1	—	—	68243-1
	6	—	1338758-1	—	—	—

¹For standard wire only.
²CERTI-CRIMP Hand Tool.
³Contains die set 58545-1. PRO-CRIMPER II commercial tool not approved for UL applications.
⁴With locator, for terminals only.

Wire Size Range
AWG 8 to 600 MCM

Product Type	AMP Wire Size	Hand Tool	Pneumatic Tooling 69015	Hydraulic Tools With Self Contained Dies		Hydraulic and Battery Powered Tools With Interchangeable Dies					Tooling For Tape Mounted Product				
				Hand Tool	Latch Head	59973-1 Hand Tool, 69065 ² & 69067 ² Latch Heads		69097 ² "C" Head		58445-1 ² Latch Head	69082 ² "C" Head	69099 ² "C" Head	Dies for 69875 AMP-TAPETRONIC	Dies for 68250-1 HD AMP-TAPETRONIC	
						Nest	Indent	Nest	Indent				Listed dies are single indent. See product information for proper tape application tooling selection		
Standard Terminals	8	69355 ¹	49956	59975-1	690692	48126	48355	46146	46145			69216	68243-1	68312-1	
	6	59083 No CERTI-CRIMP	48172			48128		46134				69217	—		68313 -1
	4	59131	48173			48129	48127	46135	46133			69218	—		—
	2		48174			48130		46136				45433	—		—
	1/0		48183			48132		46138	46137			45436	—		—
	2/0					48133	48131					45439	—		—
	3/0					48134						45442	—		—
	4/0					300430						45445	—		—
	250-300 MCM										48816	69911			
	300-350 MCM										48817	69912			
	400 MCM										48818	69913			
	500-600 MCM										48819	69914			

¹CERTI-CRIMP Hand Tool.
²These crimping heads are recommended for use only with AMP Hydraulic Hand Pump 314979-1, DYNA-CRIMP Hydraulic Power Units 69120-1 (115 VAC) and 69120-2 (230 VAC).

Introduction

Product Facts

- Product available in temperature ranges of 500°F [260°C], 550°F [288°C], 650°F [343°C] and 1200°F [649°C]
- Product employs the famous "W" and "C" crimp
- Wide range of wire sizes
- Complete line of related application tooling
- Accommodates solid and/or stranded conductors



Photo #103097

Heat...extreme heat... searing temperatures up to 1200°F [649°C]. This is one of the most challenging environments that electrical/electronic circuitry has ever entered.

If heat is an unavoidable dimension in your circuit design and production, this product is an important ally. In this line of STRATO-THERM terminals and splices, you'll find high temperature circuit hardware. You'll also find solutions to other more familiar circuit problems such as vibration, corrosion and flash-over, when they occur at high temperatures.

Different types of high temperature terminals and splices found in this catalog are as follows:

- PIDG Terminals and Splices, and Pre-Insulated Spare Wire Caps — 550°F [288°C] Range
- PIDG Insulation Restriction Terminals — 550°F [288°C] Range
- Post-Insulated Terminals and Splices — 550°F [288°C] Range
- Uninsulated Terminals and Splices — 650°F [343°C] Range
- Uninsulated Terminals and Splices — 1200°F [649°C] Range

Introduction (Continued)

PIDG Terminals and Splices, and Pre-Insulated Spare Wire Caps
550°F [288°C] Range



Designed for reliable performance up to 550°F [288°C], this line of ring-tongue terminals, butt splices and spare wire caps features a pre-insulation sleeve of TEFLON TFE insulation material. A special funnel entry feature has been added to promote easy entry and proper seating of wire. The body is copper with a choice of gold over nickel plating or nickel plating. The terminal and splice barrel accommodates stranded wire conductors only. The spare wire caps are designed for unstripped wire.

PIDG Insulation Restriction Terminals
550°F [288°C] Range



These pre-insulated insulation restriction terminals better prevent the insulation of thin-wall insulation wire from entering the terminal's wire crimp area during the crimping process.

Designed for reliable performance up to 550°F [288°C], these terminals feature a pre-insulation sleeve of TEFLON (TFE) insulation material.

Because of features such as a one-piece constructed inner sleeve and a wide funnel entry design which facilitates wire entry, standard STRATO-THERM PIDG tooling may be used to terminate this product.

Post-Insulated Terminals and Splices
550°F [288°C] Range



The temperature range of these terminals and splices is 550°F [288°C] for nickel plating and gold over nickel plated copper, and 500°F [260°C] for silver plating. These terminals and splices accommodate solid and/or stranded conductors.

Uninsulated Terminals and Splices
650°F [343°C] Range



These terminals and splices are available with and without wire insulation support. Both types are manufactured from electrolytic copper, plated with nickel. In the insulation support type, the support sleeve is fabricated from nickel-silver alloy. Both types accommodate solid or stranded conductors in various combinations. Wire size range is listed in the tabular data section.

Uninsulated Terminals and Splices
1200°F [649°C] Range



Nickel material is used for the body of both the terminal and splice. They are available with or without wire insulation support sleeve of nickel-silver alloy material. Accommodating either solid or stranded conductors in different combinations, these terminals and splices are made to cover a broad wire size range, listed in the tabular data section.

Terminals made of alumel and chromel material with nickel-silver alloy sleeves are available for thermocouple applications. When using either alumel or chromel conductors, a terminal of the same material should be selected.

Ordering Information

Introduction (Continued)

All terminals and splices are listed according to wire size and type of terminal or splice. If the part number of the terminal or splice is known, refer to the Numerical Index, at the back of this catalog, for page location of tabular data.

In the Tabular Data Section, part numbers are available in either loose piece or tape mounted form.

When ordering tape mounted part numbers, specify the terminal or splice part number, the total quantity of parts desired (if applicable). The chart to the right lists by wire size the type of packaging available and the quantity per package.

Wire Range AWG	Standard Quantities	
	Loose Piece	Tape Mounted
26-14	1,000	5,000
26-22	—	2,500
12-10	500	2,500
8, 6, 4	100	—
2, 1/2	50	—

Note: Package quantities may vary with specific part numbers.

The Crimp

All five types of STRATO-THERM terminals and splices provide optimum corrosion and vibration resistance plus outstanding tensile characteristics.

All types, except the STRATO-THERM PIDG terminals, splices and pre-insulated spare wire caps, employ the famous "W" crimp which creates the precise electromechanical properties necessary for solid and/or stranded conductor combinations. A proper crimp will provide a uniform attachment. When mechanical pressure is applied to the terminal barrel, the wire inside is forced into the serrations or dimples of the barrel. Shown are four typical photomicrographs of the "W" crimp, illustrating the results of crimping various conductor combinations. In each case, the action of the crimp has compressed the conductors and the barrel into a homogenous mass.

"W" Crimp



One Solid



**One Solid
Two Stranded**

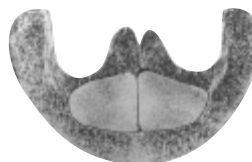

Two Solid

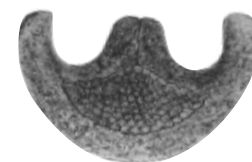

STRATO-THERM PIDG terminals and splices employ the equally reliable confined "C" crimp plus multiple position insulation support crimp for today's smaller insulated wires. This "C" crimp is especially suited to crimping the terminal barrel and insulation sleeve to stranded wire conductors. The photomicrograph shows the results of "C" crimping. Virtually the same electromechanical properties are obtained as in the "W" crimp. Pre-insulated spare wire caps and post-insulated splices are crimped with an "O" crimp configuration.

Confined C

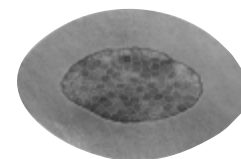

**PIDG (Pre-Insulated
DIAMOND GRIP)
Ring Tongue Terminals**

**Temperature Rating,
Material and Finish**

Insulation — TEFLON

Terminal Body — Copper per
ASTM B152

Plating — Nickel per QQ-N-290,
550°F [288°C]. Gold per MIL-G-
45204 over Nickel per QQ-N-290
500°F [260°C]

Metallic Sleeve — Copper per
ASTM B152

Plating — Nickel per QQ-N-290,
550°F [288°C]

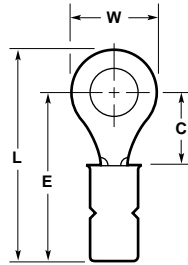

Related Product Data

Application Tooling — pages 9022
and 9023

Wire Size Circular Mils [mm ²]	Tongue Material Thickness Max.	Stud Size	Dimensions				Terminal Insulation Color	Wire Insulation Diameter Max.	Body Plating ¹	Part Number Loose Piece
			W	C Min.	E Max.	L Max.				
18-16 1,600-2,800 [0.81-1.42]	.033 0.84	4	.218 5.54	.156 3.96	.560 14.22	.672 17.07	Orange	.135 3.43	Nickel	50834
		8 M4	.312 7.92	.281 7.14	.685 17.40	.844 21.44	Orange	.135 3.43	Nickel	50836
		10	.312 7.92	.281 7.14	.685 17.40	.844 21.44	Orange	.135 3.43	Nickel	50836-1
12-10 5,180-13,100 [2.62-6.64]	.042 1.07	8 M4	.375 9.53	.302 7.67	.893 22.68	1.083 27.51	Black	.214 5.44	Nickel	50845-1
		10	.375 9.53	.302 7.67	.893 22.68	1.083 27.51	Black	.214 5.44	Nickel	50845-2
		1/4 M6	.531 13.49	.437 11.10	1.012 25.70	1.280 32.51	Black	.214 5.44	Nickel	50846

¹ Nickel plated parts are to be used with nickel plated wire. Gold plated parts are to be used with silver plated wire.
Note: "C" dimension applies from edge of metal wire barrel to center of stud hole.

**Pre-Insulated
Spare Wire Caps
(For Unstripped Wire)**

**Temperature Rating,
Material and Finish**

Insulation — TEFLON

Ring — Copper per ASTM B152

Plating — Nickel per QQ-N-290,
550°F [288°C]

Related Product Data

Application Tooling — shown to the
right



**Tool Part Number
69272-1**

Wire Insulation Diameter Range	Dimension L Max.	Ring Color	Tool Color Guide	Part Number
.075 – .087 1.91 – 2.21	.500 12.70	Black and Orange	Orange	328859

Uninsulated Terminals and Splices

**SOLISTRAND
Heat Resistant
Ring Tongue Terminals**

**Temperature Rating,
Material and Finish**

Terminal Body — Copper per
ASTM B152

Plating — Nickel per QQ-N-290,
650°F [343°C]

Related Product Data

Application Tooling — pages 9022
and 9023

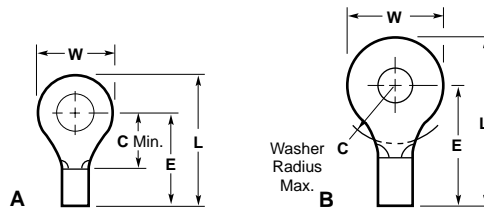

Non-Insulation Support

**Non-Insulation Support
(Wire Range 2 & 1/0)**

Wire Size Circular Mils [mm ²]	Tongue Material Thickness Max.	Stud Size	Style	Dimensions				Part Number Loose Piece
				W	C	E Max.	L Max.	
22-16 509-3,260 [0.26-1.65]	.033 0.84	6 M3.5	A	.218 5.54	.156 3.96	.337 8.56	.449 11.40	322797
			A	.281 7.14	.250 6.35	.436 11.07	.574 14.58	323219
		8 M4	A	.281 7.14	.250 6.35	.436 11.07	.574 14.58	322798
16-14 2,050-5,180 [1.04-2.62]	.033 0.84	10	A	.281 7.14	.250 6.35	.436 11.07	.574 14.58	322799
		10 1/4 M6	A	.343 8.71	.281 7.14	.462 11.73	.636 16.15	322695*
12-10 5,180-13,100 [2.62-6.64]	.042 1.07	10	A	.375 9.53	.302 7.67	.575 14.61	.765 19.43	323062
		5/16 M8	A	.531 13.49	.468 11.89	.736 18.69	1.004 25.50	323064
8 13,100-20,800 [6.64-10.5]	.051 1.30	10	A	.406 10.31	.359 9.12	.743 18.87	.949 24.10	323165
		1/4 M6	A	.469 11.91	.359 9.12	.696 17.68	.933 23.70	323166
		5/16 M8	A	.562 14.27	.406 10.31	.790 20.07	1.074 27.28	323167
6 20,800-33,100 [10.5-16.8]	.060 1.52	10	A	.468 11.89	.531 13.49	.931 23.65	1.168 29.67	323169
		3/8	A	.625 15.88	.531 13.49	.931 23.65	1.246 31.65	323172
4 33,100-52,600 [16.8-26.7]	.073 1.85	1/4 M6	A	.500 12.70	.437 11.10	.946 24.03	1.199 30.45	323173
2 52,600-83,700 [26.7-42.4]	.073 1.85	3/8	B	.625 15.88	.540 13.72	1.212 30.78	1.527 38.79	323177

*Available in small packaging quantities.

Electronics

Uninsulated Terminals and Splices (Continued)

**SOLISTRAND
Heat Resistant
Splices**

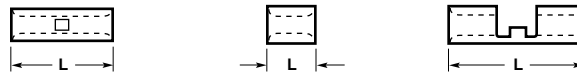

Style-A Non-Insulation Support Butt Splice **Style-B Non-Insulation Support Parallel Splice** **Style-C Non-Insulation Support Butt Splice**

Temperature Rating,
Material and Finish

Splice Body — Copper per
ASTM B152

Plating — Nickel per QQ-N-290,
650°F [343°C]

Related Product Data

Application Tooling — pages 9022
and 9023

Wire Size Circular Mils [mm ²]	Material Thickness Max.	Style	Dimensions			Part Number Loose Piece
			L Max.	ID Min.	OD Max.	
22-16 509-3,260 [0.26-1.65]	.033 0.84	A	.578 14.68	.061 1.55	.141 3.58	323796
		B	.301 7.65	.061 1.55	.141 3.58	323030
		C	.591 15.01	.061 1.55	.141 3.58	322822
16-14 2,050-5,180 [1.04-2.62]	.033 0.84	A	.567 14.40	.085 2.16	.165 4.19	323795
		B	.301 7.65	.085 2.16	.165 4.19	323794
12-10 5,180-13,100 [2.62-6.64]	.042 1.07	A	.565 14.35	.129 3.28	.226 5.74	323755
		B	.333 8.46	.129 3.28	.226 5.74	323754
8 13,100-20,800 [6.64-10.5]	.051 1.30	B	.375 9.53	.172 4.37	.296 7.52	2-34318-1

**SOLISTRAND
High Temperature
Ring Tongue Terminals**

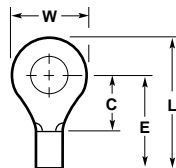

Non-Insulation Support

Temperature Rating
and Material

Terminal Body — Nickel per
ASTM B162, 1200°F [649°C]

Related Product Data

Application Tooling — pages 9022
and 9023

Wire Size Circular Mils [mm ²]	Tongue Material Thickness Max.	Color Code	Stud Size	Dimensions				Part Number Loose Piece
				W	C Min.	E Max.	L Max.	
22-16 509-3,260 [0.26-1.65]	.033 0.84	Orange	4	.218 5.54	.156 3.96	.337 8.56	.449 11.40	321884
			5 M3	.218 5.54	.156 3.96	.337 8.56	.449 11.40	321885
			6 M3.5	.281 7.14	.250 6.35	.431 10.95	.574 14.58	321889*
			8 M4	.281 7.14	.250 6.35	.431 10.95	.574 14.58	321890*
			10	.281 7.14	.250 6.35	.431 10.95	.574 14.58	321891*
16-14 2,050-5,180 [1.04-2.62]	.033 0.84	Orange	6 M3.5	.250 6.35	.171 4.34	.352 8.94	.480 12.19	322329
			8 M4	.343 8.71	.281 7.14	.462 11.73	.636 16.15	322334*
			10	.343 8.71	.281 7.14	.462 11.73	.636 16.15	322335*
			1/4 M6	.468 11.89	.437 11.10	.618 15.70	.855 21.72	322339

*Available in small packaging quantities.

Electronics

Uninsulated Terminals and Splices (Continued)

**SOLISTRAND
High Temperature
Ring Tongue Terminals**

**Temperature Rating
and Material**

Terminal Body — Nickel per
ASTM B162, 1200°F [649°C]

Related Product Data

Application Tooling — pages 9022
and 9023

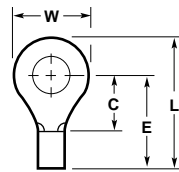

Non-Insulation Support

Wire Size Circular Mils [mm ²]	Tongue Material Thickness Max.	Color Code	Stud Size	Dimensions				Part Number Loose Piece
				W	C Min.	E Max.	L Max.	
12-10 5,180-13,100 [2.62-6.64]	.042 1.07	Orange	8 M4	.375 9.53	.281 7.14	.549 13.94	.739 18.77	323745*
			10	.375 9.53	.281 7.14	.549 13.94	.739 18.77	323680*
			1/4 M6	.531 13.49	.468 11.89	.736 18.69	1.004 25.50	323683*
8 13,100-20,800 [6.64-10.5]	.051 1.30	Orange	10	.406 10.31	.359 9.12	.743 18.87	.949 24.10	328822

*Available in small packaging quantities.

**SOLISTRAND
High Temperature
Splices**

**Temperature Rating
and Material**

Splice Body — Nickel per
ASTM B162, 1200°F [649°C]

Related Product Data

Application Tooling — pages 9022
and 9023

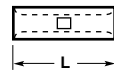

**Style-A
Non-Insulation
Support
Butt Splice**

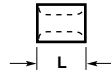

**Style-B
Non-Insulation
Support
Parallel Splice**

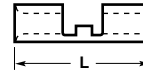

**Style-C
Non-Insulation
Support
Butt Splice**

Wire Size Circular Mils [mm ²]	Material Thickness Max.	Color Code	Style	Dimensions			Part Number Loose Piece
				L Max.	ID Min.	OD Max.	
22-16 509-3,260 [0.26-1.65]	.033 0.84	Orange	A	.578 14.68	.061 1.55	.141 3.58	322324*
			B	.301 7.65	.061 1.55	.141 3.58	322326
16-14 2,050-5,180 [1.04-2.62]	.033 0.84	Orange	A	.567 14.40	.085 2.16	.165 4.19	322345
			B	.301 7.65	.085 2.16	.165 4.19	322347
			C	.529 13.44	.085 2.16	.165 4.19	323878
12-10 5,180-13,100 [2.62-6.64]	.042 1.07	Orange	A	.567 14.40	.129 3.28	.226 5.74	323696*
			B	.333 8.46	.129 3.28	.226 5.74	323672
			C	.703 17.86	.129 3.28	.226 5.74	323698

*Available in small packaging quantities.

Electronics

**DIAMOND GRIP
Heat Resistant
Ring Tongue Terminals**

**Temperature Rating,
Material and Finish**

Terminal Body — Copper per
ASTM B152

Plating — Nickel per QQ-N-290,
650°F [343°C]

Metallic Sleeve — Nickel Silver per
ASTM B122

Related Product Data

Application Tooling — pages 9022
and 9023

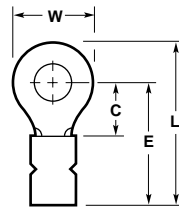

Insulation Support

Wire Size Circular Mils [mm ²]	Tongue Material Thickness Max.	Stud Size	Dimensions				Wire Insulation Diameter Max.	Part Numbers	
			W	C Min.	E Max.	L Max.		Loose Piece	Tape Mounted
22-16 509-3,260 [0.26-1.65]	.033 0.84	4	.218	.156	.512	.624	.140	322363	—
			5.54	3.96	13.00	15.85	3.56		
		6	.218	.156	.530	.645	.110	323151	—
			5.54	3.96	13.46	16.38	2.79		
		M3.5	.281	.250	.611	.749	.140	323199	—
			7.14	6.35	15.52	19.02	3.56		
		8	.281	.250	.611	.749	.140	322365	—
			7.14	6.35	15.52	19.02	3.56		
		M4	.281	.250	.629	.770	.110	323152	—
			7.14	6.35	15.98	19.56	2.79		
		10	.281	.250	.611	.749	.140	322366	—
			7.14	6.35	15.52	19.02	3.56		
10	.281	.250	.629	.770	.110	323153	—		
	7.14	6.35	15.98	19.56	2.79				
16-14 2,050-5,180 [1.04-2.62]	.033 0.84	10	.343	.281	.637	.811	.170	322375	—
			8.71	7.14	16.18	20.60	4.32		
10	.343	.281	.659	.836	.130	323161	—		
	8.71	7.14	16.74	21.23	3.30				
12-10 5,180-13,100 [2.62-6.64]	.042 1.07	6	.375	.302	.841	1.034	.230	323066	—
			9.53	7.67	21.36	26.26	5.84		
10	.375	.302	.841	1.034	.230	323068	323068-1		
	9.53	7.67	21.36	26.26	5.84				
1/4 M6	.042 1.07	1/4 M6	.531	.468	1.002	1.273	.230	323069	—
			13.49	11.89	25.45	32.33	5.84		

Note: "C" dimension applies from edge of metal wire barrel to center of stud hole.

**DIAMOND GRIP
High Temperature
Ring Tongue Terminals**

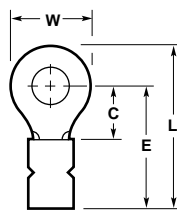

Insulation Support

**Temperature Rating and
Material**

Terminal Body — See table, 1200°F
[649°C], Nickel per ASTM B162,
Alumel —, Chromel —

Metallic Sleeve — Nickel Silver per
ASTM B122

Related Product Data

Application Tooling — pages 9021
and 9022

Wire Size Circular Mils [mm ²]	Tongue Material Thickness Max.	Stud Size	Dimensions				Body Material	Sleeve Color Code	Wire Insulation Diameter Max.	Part Number Loose Piece
			W	C Min.	E Max.	L Max.				
22-16 509-3,260 [0.26-1.65]	.033 0.84	6 M3.5	.281	.250	.611	.749	Nickel	Orange	.140	321892
			7.14	6.35	15.52	19.02			3.56	
		8	.281	.250	.611	.749	Nickel	Orange	.140	321893
			7.14	6.35	15.52	19.02			3.56	
		M4	.312	.281	.637	.796	Nickel	Orange	.140	321897
			7.92	7.14	16.18	20.22			3.56	
		10	.312	.281	.637	.796	Chromel	Gray	.140	1-321897-0
			7.92	7.14	16.18	20.22			3.56	
		10	.281	.250	.611	.749	Nickel	Orange	.140	321894
			7.14	6.35	15.52	19.02			3.56	
		10	.312	.281	.637	.796	Nickel	Orange	.140	321898
			7.92	7.14	16.18	20.22			3.56	
1/4 M6	.042 1.07	1/4 M6	.312	.281	.637	.796	Alumel	Green	.140	1-321898-0
			7.92	7.14	16.18	20.22			3.56	
1/4 M6	.042 1.07	1/4 M6	.468	.437	.793	1.031	Nickel	Orange	.140	322320
			11.89	11.10	20.14	26.19			3.56	

Note: "C" dimension applies from edge of metal wire barrel to center of stud hole.

**DIAMOND GRIP
High Temperature
Ring Tongue Terminals**

**Temperature Rating and
Material**

Terminal Body — See table, 1200°F
[649°C], Nickel per ASTM B162,
Alumel —, Chromel —

Metallic Sleeve — Nickel Silver per
ASTM B122

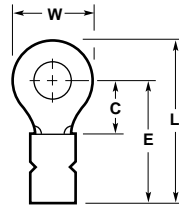

Insulation Support

Related Product Data

Application Tooling — pages 9022
and 9023

Wire Size Circular Mills [mm ²]	Tongue Material Thickness Max.	Stud Size	Dimensions				Body Material	Sleeve Color Code	Wire Insulation Diameter Max	Part Number Loose Piece	
			W	C Min.	E Max.	L Max.					
16-14 2,050-5,180 [1.04-2.62]	.033 0.84	8	.343	.281	.637	.811	Nickel	Orange	.170 4.32	322337	
		M4	8.71	7.14	16.18	20.60					
12-10 5,180-13,100 [2.62-6.64]	.042 1.07	10	.343	.281	.637	.811	Nickel	Orange	.170 4.32	322338	
			8.71	7.14	16.18	20.60					
		8	M4	.375	.281	.815	1.008	Nickel	Orange	.230 5.84	323749
				9.53	7.14	20.70	25.60				
		10	M4	.375	.281	.815	1.008	Chromel	Gray	.230 5.84	2-323749-1
				9.53	7.14	20.70	25.60				
10	M4	.375	.281	.815	1.008	Nickel	Orange	.230 5.84	323750		
		9.53	7.14	20.70	25.60						
1/4	M6	.531	.468	1.002	1.273	Alumel	Green	.230 5.84	2-323750-1		
		13.49	11.89	25.45	32.33						
1/4	M6	.531	.468	1.002	1.273	Nickel	Orange	.230 5.84	323751		
		13.49	11.89	25.45	32.33						

Note: "C" dimension applies from edge of metal wire barrel to center of stud hole.

PIDG Terminals and Splices for Thin Wall Cables

Product Facts

- All high and low temperature PIDG STRATO-THERM Terminals and Splices conform to BS 2G 178 — crimped joints for aircraft cables and wires — and meets the requirements of BS G 204, class II
- Temperature Range — -67° to +221°/+302°F [-55° to +105°/+150°C]
- European military & civil program cross references available, i.e. Pannavia, Eurofighter, Concorde, Airbus and other customer platforms
- 302°F [150°C] — High temperature
 - D.D.P. No.: GP 10 D
 - Nickel plating over copper barrel
 - TEFLON sleeve
 - Not tested up to 190°C and 260°C as set out in BS 2G 178
- 221°F [105°C] — Low temperature
 - D.D.P. No.: GP 17
 - Tin plating over copper barrel
 - Nylon sleeve
 - Compatible with all BS 2G 178 fluids, except BS 3150 and BS M 26
- Dot code feature for additional visual verification of correct cavity to terminal

association after crimp possible

- Instruction Sheet — 408-1049
- Insulated sleeves are color coded for easy identification
- Used for thin wall cable with tin or nickel plated conductors
- Nickel plated Terminals and Splices are not recommended to crimp with silver plated conductors. Gold plating is recommended for silver plated conductors.
- Inner serrated wire barrel for improved electrical conductivity and high tensile strength

The special PIDG STRATO-THERM Terminal & Splice line for thin wall aircraft cables and wires is used in nearly every Aerospace & Defense platform in Europe. We do offer this line in a low temperature 221°F [105°C] and high temperature 302°F [150°C] profile.

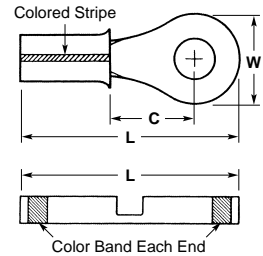

Low Temperature Range

Related Product Data

Application Tooling — page 9023

Wire Size	Stud Size				Dimensions (Max.)			Color Code	Wire Insulation Outside Dia.	Part Number			
	+/- .03 [+/- 0.8]	Metric	BA #	UN #	W	L	C						
22-24	.093 2.36	M2	8	2	.218 5.54	.652 16.56	.166 4.22	Black	.035-.075 0.90-1.90	151435			
	.119 3.02	M2.5	6	4	.218 5.54	.652 16.56	.166 4.22			151436			
					.281 7.14	.780 19.80	.25 6.35			151438			
	.145 3.68	M3	4	6	.218 5.54	.746 18.94	.265 6.73			151458			
					.281 7.14	.780 19.80	.25 6.35			151439			
	.171 4.34	M4	3	8	.281 7.14	.780 19.80	.25 6.35			151440			
					.197 5.00	—	2			10	.281 7.14	.780 19.80	.25 6.35
	20	.093 2.36	M2	8	2	.218 5.54	.662 16.81			.166 4.22	Purple w/ Red Stripe	.043-.079 1.10-2.00	152899
		.122 3.10	M2.5	6	4	.218 5.54	.662 16.81			.166 4.22			152898
						.119 3.02	M2.5			6			4
.148 3.76		M3	4	6	.281 7.14	.787 20.00	.25 6.35	152895					
					.145 3.68	M3	4	6	.250 6.35	.882 22.40			.36 9.14
.148 3.76		M3	4	6	.218 5.54	.662 16.81	.166 4.22	152897					
					.171 4.34	M4	3	8	.281 7.14	.787 20.00			.26 6.60
.200 5.08		—	2	10	.312 7.92	.834 21.18	.291 7.39	152893					
					.200 5.08	—	2	10	.312 7.92	.834 21.18			.291 7.39
.199 5.06		—	2	10	.281 7.14	.787 20.00	.26 6.60	152892					
	.268 6.81				M6	0	1/4	.469 11.91	1.07 27.13	.447 11.35	152890		
.331 8.41	M8	5/15	5/16	.469 11.91	1.07 27.13	.447 11.35	152889						
				.393 9.98	M9.5	3/8	3/8	.469 11.91	1.07 27.13	.447 11.35	152888		

Low Temperature Range
(Continued)

Related Product Data
Application Tooling — page 9023

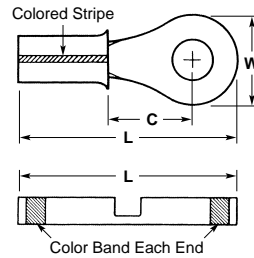

Wire Size	Stud Size				Dimensions (Max.)			Color Code	Wire Insulation Outside Dia.	Part Number					
	+/- .03 [+/- 0.8]	Metric	BA #	UN #	W	L	C								
18-16	.122 3.10	M2.5	6	4	.218 5.54	.680 17.27	.166 4.22	Orange w/ Red Stripe	.055-.106 1.40-2.70	152887					
	.125 3.18	M2.5	6	4	.240 6.09	.90 22.86	.360 9.14			154927					
	.145 3.68	M3	4	6	.281 7.14	.805 20.44	.26 6.60			152884					
					.132 3.35	.90 22.86	.37 9.39			152885					
					.218 5.54	.680 17.27	.166 4.22			152886					
	.171 4.34	M4	3	8	.312 7.92	.852 21.64	.291 7.39			152882					
					.281 7.14	.805 20.44	.268 6.80				152883				
					.312 7.92	.852 21.64	.291 7.39				152880				
					.281 7.14	.805 20.44	.26 6.60				152881				
					.265 6.73	M6	0				1/4	.469 11.91	1.09 27.58	.447 11.35	152879
					.328 8.33	M8	5/16				5/16	.469 11.91	1.09 27.58	.447 11.35	152878
	.390 9.90	M9.5	3/8	3/8	.531 13.48	1.23 31.14	.556 14.12			152877					
	14-12	.199 3.02	M2.5	6	4	.240 6.09	.974 24.73			.447 11.35	White w/ Red Stripe	.091-.126 2.30-3.20	154930		
		.145 3.68	M3	4	6	.250 6.35	.711 18.05			.181 4.59			152876		
.343 8.71						.867 22.02	.291 7.39	152874							
.171 4.34		M4	3	8	.250 6.35	.711 18.05	.181 4.59	152875							
					.343 8.71	.867 22.02	.291 7.39	152873							
.197 5.00		—	2	10	.343 8.71	.867 22.02	.291 7.39	152872							
.265 6.73		M6	0	1/4	.469 11.91	1.09 27.58	.447 11.35	152871							
.328 8.33		M8	5/16	5/16	.469 11.91	1.09 27.58	.447 11.35	152870							
.390 9.90		M9.5	3/8	3/8	.531 13.48	1.22 31.04	.556 14.12	152869							

Splices

Wire Size	Stud Size				Dimensions (Max.)			Color Code	Wire Insulation Outside Dia.	Part Number
	+/- .03 [+/- 0.8]	Metric	BA #	UN #	W	L	C			
24-22	—	—	—	—	—	1.125 28.58	—	Black	.035-.075 0.90-1.90	153400
20	—	—	—	—	—	1.135 28.82	—	Purple w/ Red Stripe	.043-.079 1.10-2.00	153401
18-16	—	—	—	—	—	.996 25.30	—	Orange w/ Red Stripe	.055-.106 1.40-2.70	153402
14-12	—	—	—	—	—	.996 25.30	—	White w/ Red Stripe	.091-.126 2.30-3.20	153403

PIDG Ring Tongue Terminals for Thin Wall Cables

High Temperature Range
Related Product Data
Application Tooling — page 9023

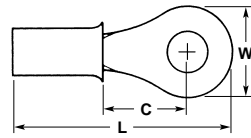

Style A

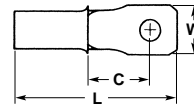

Style B

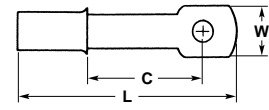

Style C

Wire Size	Stud Size			Dimensions (Max.)			Color Code	Wire Insulation Outside Dia.	Style	Part Number	
	+/- .03 [+/- 0.8]	Metric	BA #	UN #	W	L					C
22-24	.119 3.02	M2.5	6	4	.218	.657	.166	Brown	.035-.075 0.90-1.90	A	152642
					5.54	16.68	4.22				152644
	.145 3.68	M3	4	6	.281	.787	.25				152648
					7.14	19.98	6.35				152643
	.171 4.34	M4	3	8	.218	.657	.166				152645
					5.54	16.68	4.22				152646
1.97 5.00	—	2	10	.281	.787	.25	152647				
20	.093 2.36	M2	8	2	.218	.680	.166	Grey	.043-.079 1.10-2.00	A	152660
					5.54	17.27	4.22				152654
	.122 3.10	M2.5	6	4	.281	.787	.26				152659
					7.14	19.98	6.60				152655
	.148 3.76	M3	4	6	.218	.680	.166				152658
					5.54	17.27	4.22				152656
	.171 4.34	M4	3	8	.281	.787	.26				152657
					7.14	19.98	6.60				152661
	.199 5.06	—	2	10	.469	1.08	.447				152662
					11.91	27.58	11.35				152663
	.268 6.81	M6	0	1/4	.331	1.08	.447				153493
					8.41	27.58	11.35				153103
18-16	.122 3.10	M2.5	6	4	.218	.746	.26	Orange	.055-.106 1.40-2.70	A	153104
					5.54	18.94	6.60				153105
	.122 3.10	M3	6	4	.218	.681	.166				153106
					5.54	17.30	4.22				153107
	.145 3.68	M3	4	6	.281	.807	.26				153108
					7.10	20.50	6.60				153109
	.171 4.34	M4	3	8	.312	.854	.291				153175
					7.92	21.70	7.39				153176
	.197 5.00	—	2	10	.312	.854	.291				153177
					7.92	21.70	7.39				153178
.265 6.73	M6	0	1/4	.469	1.09	.447	153179				
				11.91	27.70	11.35	153180				
.328 8.33	M8	5/16	5/16	.469	1.09	.447	153181				
				11.91	27.70	11.35	153182				
.390 9.90	M9.5	3/8	3/8	.531	1.21	.531	153183				
				13.48	30.79	13.48	153184				
.125 3.17	—	—	—	.223	.902	.359	153185				
				5.66	22.90	9.11	153186				

High Temperature Range
(Continued)

Related Product Data
Application Tooling — page 9023

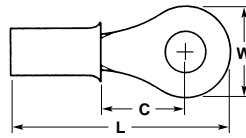

Style A

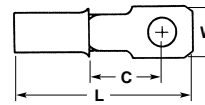

Style D

Wire Size	Stud Size				Dimensions (Max.)			Color Code	Wire Insulation Outside Dia.	Style	Part Number
	+/- .03 [+/- 0.8]	Metric	BA #	UN #	W	L	C				
14-12	.119 3.02	M2.5	6	4	.25 6.35	.711 18.06	.181 4.59	White	.091-.126 2.30-3.20	A	153110
	.145 3.68	M3	4	6	.25 6.35	.711 18.06	.181 4.59				153111
	.171 4.34	M4	3	8	.343 8.71	.867 22.02	.291 7.39				153112
	.197 5.00	—	2	10	.343 8.71	.867 22.02	.291 7.39				153113
	.265 6.73	M6	0	1/4	.469 11.91	1.08 27.58	.448 11.39				153114
	.328 8.33	M8	5/16	5/16	.469 11.91	1.08 27.58	.448 11.39				153115
	.390 9.90	M9.5	3/8	3/8	.531 13.48	1.21 30.76	.531 13.48				153116
	.119 3.02	M2.5	6	4	.218 5.44	.798 20.26	.291 7.39			D	153476
10	.119 3.02	M2.5	6	4	.280 7.10	.937 23.79	.213 5.40	Black	.102-.150 2.60-3.80	A	50844
	.145 3.68	M3	4	6	.374 9.50	1.08 27.50	.295 7.50				50845
	.171 4.34	M4	3	8	.374 9.50	1.08 27.50	.295 7.50				50845-1
	.197 5.00	—	2	10	.374 9.50	1.08 27.50	.295 7.50				50845-2
	.265 6.73	M6	0	1/4	.531 13.48	1.28 32.51	.429 10.90				50846
	.328 8.33	M8	5/16	5/16	.531 13.48	1.33 33.70	.461 11.70				50847
	.390 9.90	M9.5	3/8	3/8	.593 15.06	1.40 35.68	.531 13.48				50848

Application Tooling

Wire Size Range
AWG 26-10

Product Type	AMP Wire Size	Hand Tools	Pneumatic Tooling		Tooling For Tape Mounted Products	
			Dies for 626 Pneumatic Tools 189721-[] and 189722-[] require Straight Action Adapter ¹ 217200-1 or "C" Head Adapter 318161-1 Dies also fit 69710-1 Hand Tool		Dies for 69875 AMP-TAPETRONIC AMP-O-LECTRIC ² Requires Applicator AMPOMATOR CLS IV ² Requires Applicators	
Pre-Insulated Terminals	26-24	69692-1	69731		—	
	22-20		69732		69936	
	18-16	69693-1	69733		69937	
	14		69734		—	
Pre-Insulated Splices	12-10	—	69735		—	
	22-20	—	69327		—	
	18-16	—	69328		—	
	14-12	—	69329		—	

¹ Straight Action Adapter 217200-1 is used with Tools 189721-1 or 189722-1. "C" Head Adapter 318161-1 is used with Tools 189721-2 or 189722-2. Both adapters require the use of non-ratchet tool holder 189928-1 or ratchet tool holder 356304-1.

² Call Technical Support for Machine and Applicator part numbers.

Wire Size Range
AWG 26-6

Product Type	AMP Wire Size	Hand Tools	Hydraulic Tools With Interchangeable Dies		
			69097 ² "C" Head		69099 ² "C" Head
			Nest	Indent	
Post Insulated Terminals and Splices	26-24	45730	—	—	—
	22-20	46467, 46468 ¹	—	—	—
	18-16	46468	—	—	—
	8	—	46146	46145	69216
	6	—	46134	46133	69217

¹ Part Number 55235-1 only

² These crimping heads are recommended for use only with AMP Hydraulic Hand Pump 314979-1, DYNA-CRIMP Hydraulic Power Units 69120-1 (115 VAC) and 69120-2 (230 VAC).

Wire Size Range
AWG 22-10

Product Type	AMP Wire Size	Hand Tools	Pneumatic Tooling		Tooling For Tape Mounted Products	
			Crimping Heads for 626 Pneumatic Tool 189721-1 and 189722-1 ¹		Dies for 69875 AMP-TAPETRONIC AMP-O-LECTRIC ² Requires Applicator AMPOMATOR CLS IV ² Requires Applicators	
Uninsulated Terminals and Splices with Insulation Support	22-16	46673 46673-1	356744-1		69930	
	16-14	46988 59294	356744-2		69931	
	12-10	59461	904870-1		69932	
Uninsulated Terminals and Splices with Non-Insulation Support	22-16	—	—		69954	
	16-14	46447	217206-1		69955	
	12-10	—	—		69956	

¹ Crimping Heads require the use of non-ratchet tool holder 189767-1 or ratchet tool holder 356302-1.

² Call Technical Support for Machine and Applicator part numbers.

**Wire Size Range
AWG 8-1/0**

Product Type	AMP Wire Size	Hand Tools	Pneumatic Tooling	Hydraulic Tools With Self Contained Dies			Hydraulic Tools with Interchangeable Dies			
			69015 Head	Hand Tool	Latch Head	59973-1 Hand Tool, 69065 ² & 69067 ² Latch Heads		69097 ² "C" Head		69099 ² "C" Head
						Nest	Indent	Nest	Indent	
Uninsulated Terminals and Splices with	8	69355 ¹	49956			48126	48355	—	—	69216
	6	59083 No CERTI-CRIMP	48172			48128		—	—	69217
Non-Insulation Support	4	—	48173	59975-1	69069 ²	48129	48127	46135		69218
	2	—	48174			48130		46136	46133	45433
	1/0	—	48183	—	—	48132	48131	46138	46137	45436

¹ CERTI-CRIMP Hand Tool.

² These crimping heads are recommended for use only with AMP Hydraulic Hand Pump 314979-1, DYNA-CRIMP Hydraulic Power Units 69120-1 (115 VAC) and 69120-2 (230 VAC).

Tooling for Insulated Terminals

In order to obtain the best results from AMP terminals and splices, it is important to choose the correct tooling. Each terminal AMP manufactures is matched to

a compatible tool. By using the AMP guidelines, it's easy to select the correct tool for your application. Different types of tooling are available including hand,

pneumatic, or hydraulic. So whether you are involved in large production runs or just maintenance and repair there is a matched tool ideal for your application.



Heavy Head Tool

Hand Tooling

For repair, general maintenance or small production runs, hand tooling is the best way to a reliable termination. Easy to use, requiring no external power source, they can be easily carried from job to job. Precision crimp dies ensure a perfect termination.

AMP hand tooling meets all these requirements and more. Our un-surpassed expertise in connection technology has been used to benefit our complete range of tooling. Take for example the CERTI-CRIMP hand tool. There is a CERTI-CRIMP tool available for each terminal range. Every precision die has been constructed to the

finest engineering standards and is strong enough to be used through thousands of crimp terminations. Our ratchet device provides that the crimp cycle is completed before releasing, so it is not either under, or over-crimp any terminal.

For larger terminals a heavy duty hand tool is available which also features a similar patented ratchet device.

Terminal Type	Wire Size mm ²	Single Die		
		AWG	Hand Tool	Dot Code
PIDG Terminals for Thin Wall Cables High and Low Temperature	0.25-0.4	24-22	576778	2 dots
	0.6	20	576779	1 dot
	1.0	18	576780	2 dots
	1.2	16	576781	1 dot
	2.0	14	576782	2 dots
	3.0	12	576783	1 dot
	6.0	10	576784	1 dot

Introduction

Product Facts

- No need for inhibitor agents, thanks to our "dry crimp" technique
- Terminating/splicing capabilities for stranded aluminum wire, plus splicing of aluminum wire to copper wire conductors
- Wide wire-size range — aluminum 8 to 4/0 [8.6 to 110.9 mm²] and copper 10 to 3/0 [4.8 to 85.9 mm²]
- Efficient production rates, uniform reliability, at low cost — all because of AMP electro-hydraulic DYNA-CRIMP Tooling
- Optimum electrical, environmental, and mechanical performance crimps from AMP three-stage dies
- Portable battery powered hydraulic unit is available and low pressure crimp dies for 2/0 size

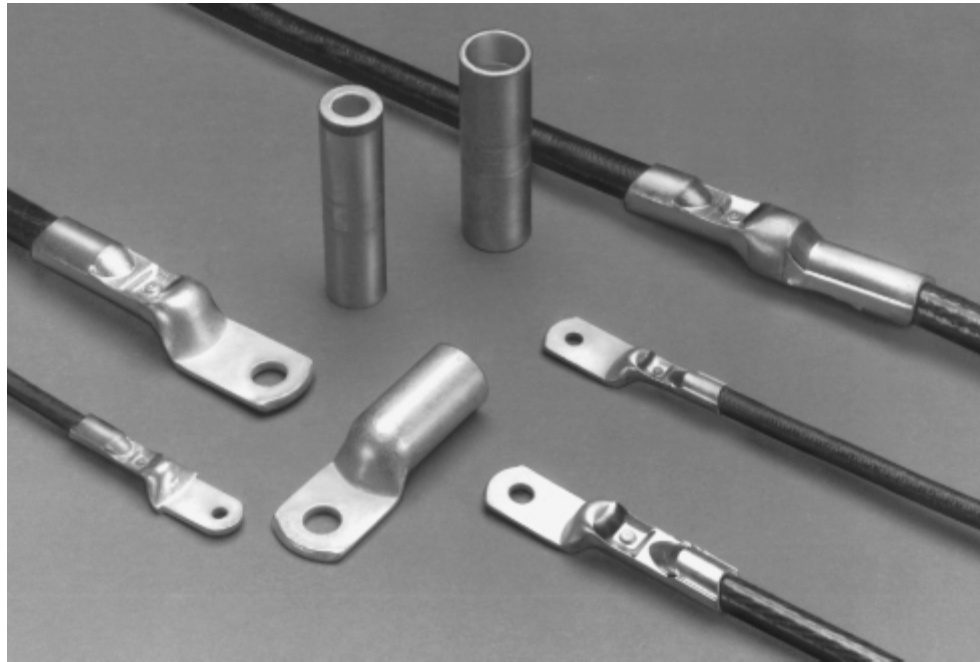

AMP COPALUM Sealed Terminals and Splices are designed especially for solving the inherent problems of terminating aluminum conductors. These connectors are terminated to stranded aluminum wire using a "dry crimp." This technique eliminates the need for an inhibitor agent to break down the highly tenacious and inert oxides that form on aluminum conductors. An extremely efficient and reliable crimping method, the dry crimp also produces a sealed connection that better prevents re-oxidation and corrosion when intimate terminal/conductor contact is achieved.

AMP COPALUM Sealed Terminals and Splices are available for terminating and splicing stranded aluminum wire in sizes ranging from 8 to 4/0 [8.6 to 110.9 mm²] and copper 10 to 3/0 [4.8 to 85.9 mm²]. With the capability of splicing aluminum wire to copper wire, these connectors are generally applicable wherever aluminum wire or cable is

used. AMP COPALUM Sealed Terminals and Splices are especially suited for the aerospace industry.

Each connector body is constructed of tin-plated copper and houses a nickel-plated brass insert and funnel. The funnel is designed to better prevent wire strands from hanging up when inserted into the wire barrel. The perforated insert enhances reliability for the terminal and splice when crimped to the aluminum/copper conductors.

During the crimping operation, the relatively soft conductor material extrudes through the insert holes, causing the brittle oxide to be sheared, and clean conductor metal to be brought into intimate contact with the inner surfaces of the body and insert. These areas of extrusion form an air- and moisture-tight seal, minimizing oxidation and corrosion.

Stranded-wire crimping also produces "cold welding" or solid-phase bonding

between each wire strand. During the crimping process, deformation pressure is applied from several planes, causing sufficient plastic flow of the conductor material. This fractures the oxide film on each wire strand and induces different rates of extrusion. The resulting wiping action under pressure produces interstrand bonding, yielding many contact surfaces and a substantial increase in the contact area. Excellent electrical characteristics are thus achieved.

The increase in contact area also decreases the chances of electrical malfunction due to creep, differences in thermal expansion, and corrosion. Also the insert grips the conductor securely, providing a good mechanical connection.

Economical termination of these connectors becomes a reality with the use of the AMP electro-hydraulic DYNA-CRIMP Tool. This tool is equipped with a uniquely designed die that simultaneously produces three distinct crimps.

Technical Documents

Instruction Sheets

- 408-2281 — Application Terminals and Splices Tooling
- 408-2453 — Tool 69066/Crimping Die
- 408-9535 — Tool 58422-1

Product Specifications

- 108-11011 — Overall Aluminum Wires
- 108-11011-1 — Copper Wires
- 108-11011-2 — High Temp. Wires with Flag Terminals

Application Specifications

114-2134

Introduction (Continued)

The AMP Sealed COPALUM terminal and splice product line was established in the 50's. Originally it had two separate product lines, one for aluminum wire and one for copper wire. Each line had butt connectors and terminals.

The Aluminum wire connector bodies were made of stamped and formed aluminum strip stock and COPALUM terminal connector bodies were made of stamped and formed copper strip stock.

Both products contained a closed cup (cartridge) installed within each wire barrel. This cartridge contained an oxide inhibiting compound with abrasive particles that flowed during crimping into the strand voids (interstices) and mechanically abraded the wire and barrel oxide surfaces. The oxide inhibitor protected the contact surfaces from further oxidation and formed a temporary partial seal between the conductor and the crimped insulation support.

The crimp dies were the two stage type and of the confined crescent design. The first stage crimped the wire barrel and cartridge, while the second stage crimped only the flared cartridge end. This second stage crimp produced the insulation support which was designed as a strain relief.

In the 60's, all copper bodies and perforated inserts were introduced. The industry wanted a dry crimp with a fully sealed body. Some important advantages of the copper design are:

1. Almost all buss contacts are copper. The plated terminal tongue needs no special contact surface treatment against the bolted copper buss. This is the (dynamic), disconnectable part of the connection.
2. The copper wire barrel allows for a natural two step down capacity from an equivalent aluminum wire to copper wire.
Example—#4 aluminum down to #6 copper.
3. The more dense copper has 100% electrical conductivity compared to aluminum at 61% maximum. Copper compared to aluminum has hardly any mechanical creep; therefore, with the proper crimp, it provides a much more stable crimped (static), permanently sealed connection.
4. Within the circuit design there is always a need to change from high temperature copper wires to lower temperature aluminum wires. With the copper connector, we have the choices of "optional" (4 AL-6 CU) or "primary" (4 AL-4 AL) or "secondary" (6 CU-6CU) all within the same wire barrel and crimp die envelope.
5. During crimping, the hard nickel plated perforated insert digs into and intimately connects the wire and copper body while at the same time increasing the fresh surface contact areas via the holes and extrusion. With this feature, we now have a preferred "dry" connection with the copper to aluminum transition occurring inside the connector body where it is protected and controlled.
6. The barrier walls of the terminal and splice body provide the blind hole required for an environmentally sealed crimp.
7. The product has a three stage simultaneous crimp design which allows for a very secure electrical crimp, a smooth transition crimp which goes up to the full round sealing crimp. It also has an identification feature and maintains maximum connector wall thickness after crimp.

We made several changes to the product line in the 80's and also changed the part numbers as listed below.

1. The perforated insert was modified without causing a change in connector performance.
2. The internal components were oriented and permanently locked in place during manufacture.
3. Clearer, more permanent marking was introduced with the straight knurl stripes replacing the blue ink stripe guides used to show crimp location.

Tyco Electronics continually monitors incoming material for material conformance. Consolidation of production facilities and improved equipment produce more accurate component parts which, after heat treatment and plating, yield an overall higher quality assembly. All customer drawings are now on new formats and are on CAD. Catalog and instructional materials are regularly updated.

In April 1993, a new application sheet 114-2134 was completed. Also in 1993, we released a whole line of two stud hole terminals, silver plated with high temperature terminals, two 4/0 AL style terminals, a new crimp die, and various sheared tongue styles.

Using engineering tools like CAE/CAD/CAM, thermography, and computer driven image analysis on crimp cross-sections, we are able to arrive at and maintain optimum product integrity and reliability.

As with all AMP products, we have a continuing program of product and process improvements to promote maximum performance to meet customer's needs.

Single Hole Ring Tongue Terminals

Standard Tongue

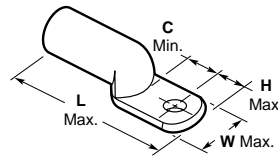

Sheared Tongue

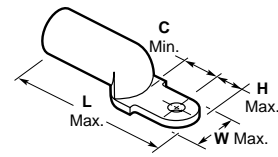

Wire Size Circular Mils mm ²		Insul. Dia. Range	Tongue Thickness (Nom.)	Stud Size	Tongue Type	Dimensions				Part Number	Weight Grams*	Tooling for Power Unit 69120-1 or -2						
Aluminum	Copper					H Max.	L Max.	W Max.	C Min.			Heads	Die					
8 16564 8.6	10 9354 4.8	.182-.200 4.62-5.08	.069 1.75	10	—	.291 7.39	1.66 42.16	.592 15.04	.50 12.70	277147-1	11.0	69066 or 58422-1	68006					
				1/4 6.35						277147-3	—							
				3/8 9.52						277147-2	10.0							
				10						Sheared	.250 6.35			1.63 41.40	.492 12.50	.54 13.72	277147-5	10.3
6 28280 14.6	8 16983 8.8	.225-.250 5.72-6.35	.088 2.24	10	—	.310 7.88	1.90 48.26	.627 15.92	.47 11.94	277148-1	16.8	69066 or 58422-1	68007					
				1/4 6.35						277148-2	16.6							
				5/16 7.92						277148-3	16.2							
				3/8 9.52						277148-4	15.3							
4 42420 21.9	6 26818 13.8	.276-.305 7.01-7.75	.082 2.08	10	—	.310 7.88	2.00 50.8	.627 15.92	.53 13.46	277154-1	15.2	69066 or 58422-1	68008					
				1/4 6.35						277148-7	15.0							
				3/8 9.52						277149-5	—							
				1/4 6.35						277149-2	19.4							
2 67872 35.0	4 42615 22.0	.340-.380 8.64-9.65	.093 2.36	1/4 6.35	—	.335 8.51	2.37 60.20	.675 17.15	.54 13.72	277149-3	18.9	69066 or 58422-1	68009					
				3/8 9.52						277149-4	18.5							
				1/4 6.35						Sheared	.310 7.88			2.00 50.8	.627 15.92	.53 13.46	277149-8	18.5
				1/4 6.35						277150-1	36.0							
1/0 107464 55.5	2 66500 34.3	.425-.470 10.79-11.94	.101 2.57	1/4 6.35	Short	.401 10.19	2.51 63.75	.812 20.62	.49 12.45	277150-3	34.0	69066 or 58422-1	68010-1					
				3/8 9.52						277151-1	53.3							
				5/16 7.92						277151-7	—							
				1/4 6.35						Long	.448 11.38			2.73 69.34	.812 20.62	.72 18.29	277151-5	57.0
2/0 138168 71.3	1/0 104500 53.9	.500-.550 12.7-13.97	.128 3.25	1/4 6.35	Short	.451 11.46	2.81 71.37	.911 23.14	.51 12.95	277151-3	—	69066 or 58422-1	314964-1 or 68011-1					
				3/8 9.52						277152-1	—							
				5/16 7.92						277152-2	76.3							
				3/8 9.52						Long	.451 11.46			3.05 77.47	.911 23.14	.75 19.05	277152-3	80.0
3/0 168872 87.2	2/0 133000 68.6	.520-.645 13.21-16.38	.132 3.35	1/2 12.7	Long (Narrow)	.430 10.93	3.05 77.47	.850 21.59	.75 19.05	277152-4	81.0	58422-1	59877-1					
				3/8 9.52						277152-5	78.0							
				3/8 9.52						277153-1	103.0							
				1/2 12.7						55944-1	81.0							
4/0 214928 110.94	3/0 166500 85.94	.590-.680 14.99-17.27	.177 4.50	3/8 9.52	—	.440 11.18	3.11 79.00	1.00 25.4	.73 18.54	55995-1 (55995-2)	100	58422-1	314948-1					
				1/2 12.7						184113-1	98.0							

*Aluminum 8 to 2 = ±3 grams; aluminum 1/0 to 3/0 = ±5 grams

Double Hole Ring Tongue Terminals

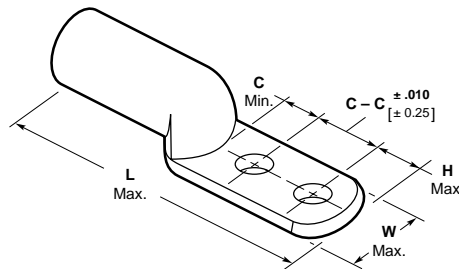

Wire Size Circular Mils mm ²		Insul. Dia. Range	Tongue Thickness (Nom.)	Stud Size	Tongue Type	Dimensions					Part Number	Weight Grams*	Tooling for Power Unit 69120-1 or -2	
Aluminum	Copper					H Max.	L Max.	W Max.	C - C	C Min.			Heads	Die
6 28280 14.6	8 16983 8.8	.225-.250 5.72-6.35	.088 2.24	1/4 6.35 3/8 9.52	Two Hole	.38 9.65	2.89 73.41	.63 16.00	1.00 25.4	.44 11.18	55832-1 24 55832-2 23	69066 or 58422-1	68007	
4 42420 21.9	6 26818 13.8	.276-.305 7.01-7.75	.082 2.08	1/4 6.35 3/8 9.52	Two Hole	.38 9.65	2.94 74.68	.63 16.00	1.00 25.4	.44 11.18	55833-1 (55834-1) 26 55833-2 (55834-2) 25	69066 or 58422-1	68008	
2 67872 35.0	4 42615 22.0	.340-.380 8.64-9.65	.093 2.36	1/4 6.35 3/8 9.52	Two Hole	.38 9.65	3.27 83.06	.68 17.27	1.00 25.4	.44 11.18	55835-1 (55836-1) 44 55835-2 (55836-2) 43	69066 or 58422-1	68009	
1/0 107464 55.5	2 66500 34.3	.425-.470 10.79-11.94	.101 2.57	3/8 9.52	Two Hole	.38 9.65	3.39 86.11	.81 20.57	1.00 25.4	.44 11.18	55837-1 (55838-1) 62	69066 or 58422-1	68010-1	
2/0 138168 71.3	1/0 104500 53.9	.500-.550 12.7-13.97	.128 3.25	3/8 9.52	Two Hole	.38 9.65	3.66 92.96	.91 23.11	1.00 25.4	.44 11.18	55839-1 (55844-1) 91	69066 or 58422-1	314964-1 or 68011-1	
3/0 168872 87.2	2/0 133000 68.6	.520-.645 13.21-16.38	.132 3.35	3/8 9.52	Two Hole	.38 9.65	3.82 97.03	1.00 25.4	1.00 25.4	.44 11.18	55840-1 113	58422-1	59877-1	
4/0 214928 110.94	3/0 166500 85.94	.590-.680 14.99-17.27	.177 4.50	3/8 9.52	Two Hole	.38 9.65	3.72 94.49	1.00 25.4	1.00 25.4	.44 11.18	(55841-1) 113	58422-1	314948-1	

Note: Part numbers with () are silver plated, part numbers without are tin plated.
 * Aluminum 8 to 2 = ±3 grams; aluminum 1/0 to 4/0 = ±5 grams.

Flag Terminals

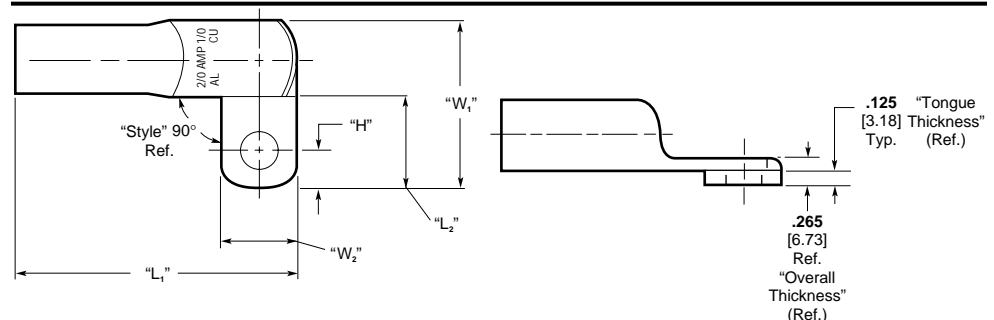

Wire Size Circular Mils mm ²		Insul. Dia. Range	Tongue Thickness (Ref.)	Stud Size	Tongue Style	Dimensions					Part Number	Weight Grams*	Tooling for Power Unit 69120-1 or -2	
Aluminum	Copper					H Max.	L ₂ Max.	L ₂ Min.	W ₁ Max.	W ₂ Max.			Heads	Die
2/0 138168 71.3	1/0 104500 53.9	.500-.550 12.7-13.97	.125 3.18	3/8 9.52	One Hole 90° Right Hand	.43 10.9	3.185 80.90	.970 24.64	1.870 47.50	.850 21.59	55982-1 109	69066 or 58422-1	314964-1 or 68011-1	

* Aluminum 8 to 2 = ±3 grams; aluminum 1/0 to 4/0 = ±5 grams.

Standard Butt Splices

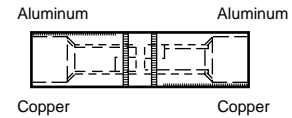
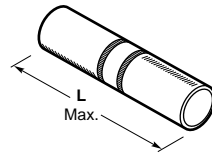

Wire Size* Circular Mils mm ²		Insul. Dia. Range	L Max.	Part Number	Weight Grams**	Tooling for Power Unit 69120-1 or -2	
Aluminum	Copper					Heads	Die
8 16564 8.6	10 9354 4.8	.182–.200 4.62–5.08	1.41 35.81	277156-1	10.2	69066 or 58422-1	68006
6 28280 14.6	8 16983 8.8	.225–.250 5.72–6.35	1.80 45.72	277157-1	16.9	69066 or 58422-1	68007
4 42420 21.9	6 26818 13.8	.276–.305 7.01–7.75	2.17 55.12	277158-1	26.8	69066 or 58422-1	68008
2 67872 35.0	4 42615 22.0	.340–.380 8.64–9.65	2.54 64.52	277159-1	50.3	69066 or 58422-1	68009
1/0 107464 55.5	2 66500 34.3	.425–.470 10.79–11.94	2.67 67.82	277160-1	76.0	69066 or 58422-1	68010-1
2/0 138168 71.3	1/0 104500 53.9	.500–.550 12.70–13.97	3.01 76.45	277161-1	107.7	58422-1 or 69066	68011-1 or 314964-1
3/0 168872 87.2	2/0 133000 68.6	.520–.645 13.21–16.38	3.26 82.80	277162-1	127.5	58422-1	59877-1

* For aluminum-to-aluminum applications, splices will accept the same wire size at either end. For aluminum-to-copper applications, however, the size of the copper wire must be "stepped down" two wire sizes to compensate for differences in the electrical ratings of copper and aluminum.

** Aluminum 8 to 2 = ±3 grams; aluminum 1/0 to 3/0 = ±5 grams

Transitional Butt Splices

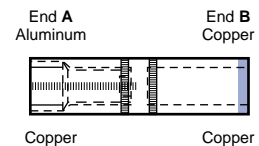
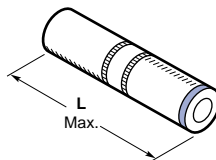

Wire Size Circular Mils mm ²		Insul. Dia. Range		L Max.	Part Numbers	Weight Grams*	Tooling for Power Unit 69120-1 or -2	
End A	End B	End A	End B				Heads	Die
6 28280 14.6	6 26818 13.8	.225–.250 5.72–6.35	.225–.250 5.72–6.35	1.80 45.72	55984-1**	16	69066 or 58422-1	68007
4 42420 21.9	8 16983 8.8	.276–.305 7.01–7.75	.210–.255 5.33–6.48	1.91 48.51	277164-1	26.5	69066 or 58422-1	68008
4 42420 21.9	4 42615 22.0	.276–.305 7.01–7.75	.276–.305 7.01–7.75	2.17 55.12	277165-1**	26.0	69066 or 58422-1	68008
1/0 107464 55.5	4 42615 22.0	.425–.470 10.80–11.94	.276–.305 7.01–7.75	2.70 68.58	277163-1	92.5	69066 or 58422-1	68010-1
3/0 168872 87.2	1/0 104500 53.9	.520–.645 13.21–16.38	.430–.495 10.92–12.57	3.26 82.80	277168-1	128.5	58422-1	59877-1

* ±10 grams

** Transitional splice test amperage is for aluminum wire.

Application Tooling

The AMP COPALUM Sealed Terminals and Splices are designed to be terminated with precision die sets, crimping heads, and hydraulic power units. The die set to use will depend on the conductor material size to be terminated. Both crimping heads can be used for the smaller conductor sizes. The largest conductor sizes will require the use of the heavier head. Hydraulic power can be provided by either the Electric/Hydraulic Power Unit or the Hydraulic Foot Pump.

DYNA-CRIMP Electric-Hydraulic Power Unit

The DYNA-CRIMP Power Unit is an electric hydraulic tool. It can accommodate various heads and dies for terminating AMP terminals and splices ranging in size from 8 to 1500 MCM. A complete accessory line is also available with the tool for use in portable and stationary applications as well as for multiple-head crimping.



**Hydraulic Foot Pump
314979-1**
(409-1980)
†Reference Hose Assembly



DYNA-CRIMP Electric-Hydraulic Power Unit
(Includes Pressure Release)
115 Volts (60 Hz) — 69120-1
230 Volts (50/60 Hz) — 69120-2
(409-1950)



**Crimping Head
58422-1**
(408-9535)



**Crimping Head
69066**
(408-2453)



Typical Die Set
(408-2281)

Wire Size AWG	Crimp Tool Components		
	Aluminum	Copper	Die Sets Heads Power Units
8		10	68006
6		8	68007
4		6	68008
2		4	68009
1/0		2	68010-1
			68011-1
2/0		1/0	314964-1
3/0		2/0	59877-1
4/0		3/0	314948-1

*For aluminum conductor range of 8 through 1/0 and copper conductor range of 10 through 2.

**For aluminum conductor range of 8 through 4/0 and copper conductor range of 10 through 3/0.

***Portable—low pressure crimp die.

Accessory Power Controls and Hoses For DYNA-CRIMP Electric-Hydraulic Power Unit

Consult the table to the right for accessory power controls and hoses. Control and hose accessories must be ordered separately.

If electric hydraulic tool is to be used in portable applications, a handle control and hose assembly should be used.

For stationary applications, a foot switch assembly and hose assembly will be necessary.

Multidirectional valves are used when more than one crimping head is permanently attached to the tool.

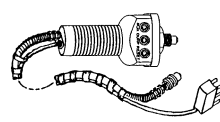

Handle Control



Hose Assembly

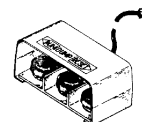

Foot Control

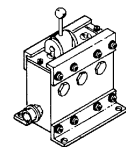

Multidirectional Valve

For use with Power Unit No.	Accessory Description	Accessory Part Number	Remarks
69120-1 69120-2	7 ft. [2.13 m] Handle Control Assembly — Hose and Cord	59907-7	Pressure Release included with handle control
	15 ft. [4.57 m] Handle Control Assembly — Hose and Cord	1-59907-5	
	15 ft. [4.57 m] Handle Control Assembly — Cord (Less Hose)	1-59908-5	
	21 ft. [6.4 m] Handle Control Assembly — Hose and Cord	2-59907-1	
	21 ft. [6.4 m] Handle Control Assembly — Cord (Less Hose)	2-59908-1	
	28 ft. [8.53 m] Handle Control Assembly — Hose and Cord	2-59907-8	
69120-1 69120-2	15 ft. [4.57 m] Foot Switch Assembly	68284-1	Needs Hose Assembly
	3 ft. [0.91 m] Hose Assembly	59909-3	68284-1 Foot Switch or Foot Pump Assembly needed with these Hose Assemblies
	7 ft. [2.13 m] Hose Assembly	59909-7	
	15 ft. [4.57 m] Hose Assembly†	1-59909-5	
21 ft. [6.4 m] Hose Assembly	2-59909-1		
69120-1 69120-2	3-Way Multi-Directional Valve	59220	For use with Foot Switch only
	3-Way Multi-Directional Valve (Elec. Control)	59220-2	

Introduction

Product Facts

- Pre-insulated terminal designed for complete and uniform reliability in difficult circuit environments
- PIDG Terminals consist of tin plated copper or tin plated phosphor bronze body for spring spades with a copper sleeve and insulation sleeve fitted over terminal barrel
- Design of the tool dies and construction of the terminal ensures uniform insulation thickness under crimping pressure, transmitting this pressure evenly to the center of the crimp area

The AMP Mated Tool/Terminal Concept

- AMP compression crimping produces crimps for a given size wire and terminal that are precisely alike in appearance and performance
- Terminal and crimping tool are designed as precisely matched devices
- Dies are precision-engineered from the finest hard-metal alloys
- Crimping pressure is controlled by a ratchet device on the hand tool or a corresponding pre-calibration in the crimping jaws of AMP automated crimping machines

The Crimp

- Crimping pressure can neither overstress nor understress the terminal barrel — machined dies fully bottom to the precise crimp height
- Resulting termination is free of contamination
- Resistant to shock and critical environments
- Tensile strength approaches that of the wire itself
- PIDG Terminals meet or exceed the requirements of MIL-T-7928, Type II, Class 1 and 2

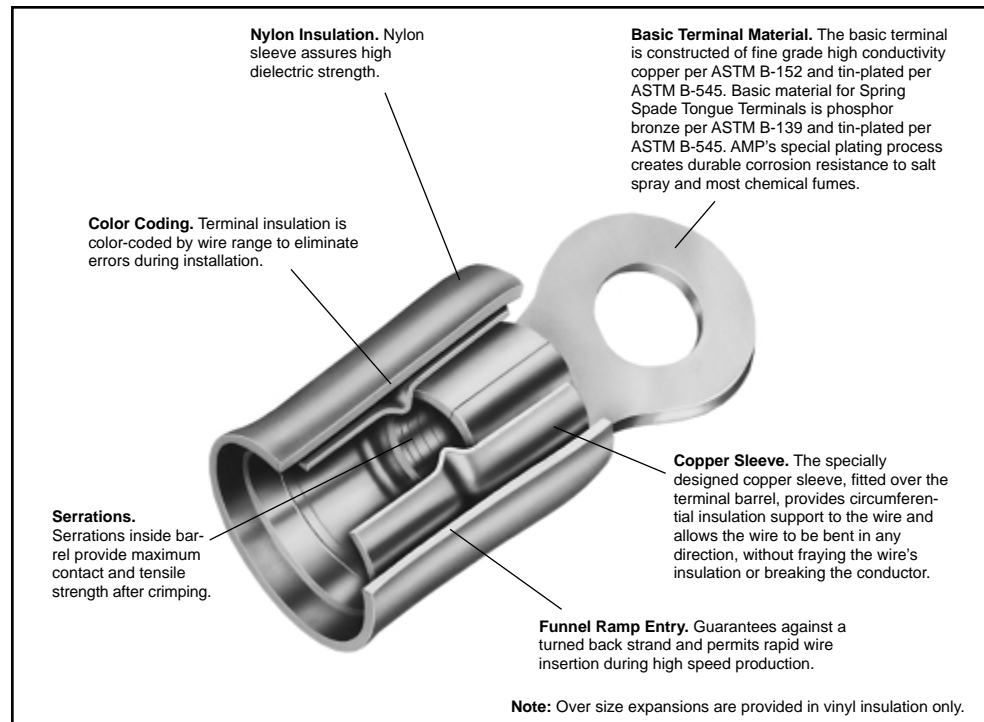

Temperature Rating: 221°F [105°C] Max.

**AMP PIDG Terminals
(Use PIDG Tooling)**

AMP Wire Range	UL Listed	SP Certified	LR7189 Certified
22-16	22-16 Solid or Stranded	300 V Max.,	
16-14	16-14 Solid or Stranded	221°F [105°C]. Max. ¹	
12-10	12-10 Solid or Stranded		

Note: 22-16 terminals are stamped 22-18 in accordance with MIL-T-7928.
¹UL & CSA — Nylon

**AMP PIDG Nylon Butt Window Splice
(Use PIDG Tooling)**

AMP Wire Range	UL Listed	SP Certified	LR7189 Certified
22-16	22-16 Stranded or Solid	300 V Max.,	
16-14	16-14 Stranded or Solid	221°F [105°C]. Max.	
12-10	12-10 Stranded or Solid		

Note: 22-16 splices are stamped 22-18 in accordance with MIL-T-7928.

Material and Finish

Insulation — Nylon

Terminal Body and Metallic

Sleeve — Copper per ASTM B-152

Plating — Tin per ASTM B-545

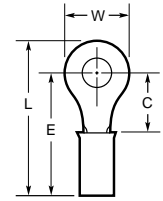

Military Specifications MS25036

Wire Size Circular Mils [mm ²]	Tongue Material Thickness Max.	Stud Size	Dimensions				Terminal Insulation Color	Wire Insulation Diameter Max.	Class	MS25036 Dash Numbers	Part Numbers			
			W	C Min.	E Max.	L Max.					Loose Piece	Tape Mounted		
26-24 238-475 [0.12-0.24]	.029 0.74	2 M2	.203 5.16	.211 5.36	.632 16.05	.739 18.77	Yellow	.105 2.67	1 & 2	143	54310-1†	—		
		4	.203 5.16	.211 5.36	.632 16.05	.736 18.69	Yellow	.105 2.67	1 & 2	144	52189†	—		
		6 M3.5	.250 6.35	.243 6.17	.664 16.87	.792 20.12	Yellow	.105 2.67	1 & 2	145	53073†	—		
		8 M4	.281 7.14	.250 6.35	.671 17.04	.814 20.68	Yellow	.105 2.67	1 & 2	146	54311-1†	—		
		10	.312 7.92	.281 7.14	.702 17.83	.868 22.05	Yellow	.105 2.67	1 & 2 2	147	54312-1†	—		
26-22 202-810 [0.10-0.41]	.020 0.51	2 M2	.203 5.16	.211 5.36	.542 13.77	.646 16.41	Yellow	.082 2.08	2	143	323913	—		
		4	.203 5.16	.211 5.36	.542 13.77	.646 16.41	Yellow	.082 2.08	2	144	323914*	2-323914-1		
		8 M4	.250 6.35	.281 7.14	.612 15.54	.740 18.80	Yellow	.082 2.08	2	146	323916	2-323916-1		
		10	.250 6.35	.281 7.14	.612 15.54	.740 18.80	Yellow	.082 2.08	2	147	324075*	2-324075-1		
22-16 509-3,260 [0.26-1.65]	.033 0.84	4	.218 5.54	.156 3.96	.560 14.22	.672 17.07	Red	.125 3.18	1 & 2 2	148	320553	—		
			.218 5.54	.156 3.96	.560 14.22	.672 17.07	Red	.140 3.56	1 & 2 2	148	31880*	—		
		6 M3.5	.218 5.54	.156 3.96	.560 14.22	.672 17.07	Red	.125 3.18	1 & 2 2	101	36149*	—		
			.218 5.54	.156 3.96	.560 14.22	.672 17.07	Red	.140 3.56	1 & 2 2	101	36150*	—		
		8 M4	.250 6.35	.250 6.35	.654 16.61	.782 19.86	Red	.125 3.18	1 & 2 2	102	51863*	—		
			.312 7.92	.281 7.14	.685 17.40	.844 21.44	Red	.125 3.18	1 & 2 2	149	320551*	—		
		10	.312 7.92	.281 7.14	.685 17.40	.844 21.44	Red	.140 3.56	1 & 2 2	149	31890*	—		
			.312 7.92	.281 7.14	.685 17.40	.844 21.44	Red	.125 3.18	1 & 2 2	103	36153*	—		
		1/4 M6	.312 7.92	.281 7.14	.685 17.40	.844 21.44	Red	.140 3.56	1 & 2 2	103	36154*	—		
			.469 11.91	.437 11.10	.841 21.36	1.078 27.38	Red	.125 3.18	1 & 2 2	150	320571*	—		
		22-16 509-3,260 [0.26-1.65]	.033 0.84	5/16 M8	.469 11.91	.437 11.10	.841 21.36	1.078 27.38	Red	.125 3.18	1 & 2 2	104	320572*	—
					.469 11.91	.437 11.10	.841 21.36	1.078 27.38	Red	.140 3.56	1 & 2 2	104	31895*	—
3/8	.531 13.49			.546 13.87	.950 24.13	1.218 30.94	Red	.125 3.18	1 & 2 2	105	320573*	—		
	.531 13.49			.546 13.87	.950 24.13	1.218 30.94	Red	.140 3.56	1 & 2 2	105	31897*	—		
1/2 M12	.713 18.11			.530 13.46	.934 23.72	1.293 32.84	Red	.125 3.18	1 & 2	151	328975*	—		

*Available in small packaging quantities.

Note: "C" dimension applies from edge of metal wire barrel to center of stud hole.

†Must be crimped with 22-18 or 22-16 PIDG (red) Tooling.

Material and Finish

Insulation — Nylon

Terminal Body and Metallic

Sleeve — Copper per ASTM B-152

Plating — Tin per ASTM B-545

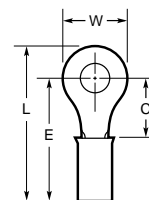

Military Specifications MS25036 (Continued)

Wire Size Circular Mils [mm ²]	Tongue Material Thickness Max.	Stud Size	Dimensions				Terminal Insulation Color	Wire Insulation Diameter Max.	Class	MS25036 Dash Numbers	Part Numbers			
			W	C Min.	E Max.	L Max.					Loose Piece	Tape Mounted		
16-14 2,050-5,180 [1.04-2.62]	.033 0.84	4	.250 6.35	.171 4.34	.575 14.61	.703 17.86	Blue	.150 3.81	1 & 2	152	324159*	—		
		6 M3.5	.250 6.35	.171 4.34	.575 14.61	.703 17.86	Blue	.150 3.81	1 & 2 2	106	320561	—		
			.312 7.92	.281 7.14	.685 17.40	.844 21.44	Blue	.150 3.81	1 & 2 2	107	51864*	—		
		8 M4	.312 7.92	.281 7.14	.685 17.40	.844 21.44	Blue	.150 3.81	1 & 2 2	153	51864-1*	—		
			.312 7.92	.281 7.14	.685 17.40	.844 21.44	Blue	.150 3.81	1 & 2 2	108	51864-2*	—		
		1/4 M6	.469 11.91	.437 11.10	.841 21.36	1.078 27.38	Blue	.150 3.81	1 & 2 2	154	320563*	—		
			.469 11.91	.437 11.10	.841 21.36	1.078 27.38	Blue	.150 3.81	1 & 2 2	109	320575*	—		
		3/8 M8	.531 13.49	.546 13.87	.950 24.13	1.218 30.94	Blue	.150 3.81	1 & 2 2	110	320564*	—		
			.531 13.49	.546 13.87	.950 24.13	1.218 30.94	Blue	.150 3.81	1 & 2 2	155	328976	—		
		12-10 5,180-13,100 [2.62-6.64]	.042 1.07	6 M3.5	.375 9.53	.302 7.67	.893 22.68	1.083 27.51	Yellow	.230 5.84	1 & 2 2	111	320567*	—
					.375 9.53	.302 7.67	.893 22.68	1.083 27.51	Yellow	.250 6.35	1 & 2 2	111	35107	—
				8 M4	.375 9.53	.302 7.67	.893 22.68	1.083 27.51	Yellow	.230 5.84	1 & 2 2	156	320568*	—
					.375 9.53	.302 7.67	.893 22.68	1.083 27.51	Yellow	.250 6.35	1 & 2 2	156	35108*	—
				10 M6	.375 9.53	.302 7.67	.893 22.68	1.083 27.51	Yellow	.230 5.84	1 & 2 2	112	36161*	—
.375 9.53	.302 7.67				.893 22.68	1.083 27.51	Yellow	.250 6.35	1 & 2 2	112	35109*	—		
1/4 M8	.531 13.49			.468 11.89	1.054 26.77	1.322 33.58	Yellow	.230 5.84	1 & 2 2	157	320569*	—		
	.531 13.49			.468 11.89	1.054 26.77	1.322 33.58	Yellow	.250 6.35	1 & 2 2	157	35110*	—		
5/16 M10	.531 13.49			.468 11.89	1.054 26.77	1.322 33.58	Yellow	.230 5.84	1 & 2 2	113	320576*	—		
	.531 13.49			.468 11.89	1.054 26.77	1.322 33.58	Yellow	.250 6.35	1 & 2 2	113	35111*	—		
3/8 M12	.593 15.06			.531 13.49	1.115 28.32	1.414 35.92	Yellow	.230 5.84	1 & 2 2	114	320577*	—		
	.593 15.06			.531 13.49	1.115 28.32	1.414 35.92	Yellow	.250 6.35	1 & 2 2	114	35112*	—		
1/2 M16	.715 18.16			.474 12.04	1.065 27.05	1.414 35.92	Yellow	.230 5.84	2	158	52077	—		

*Available in small packaging quantities.

Note: "C" dimension applies from edge of metal wire barrel to center of stud hole.

Electronics

Ring Tongue Terminals — Insulation Restricting

Material and Finish

Insulation — Nylon
Terminal Body — Copper per ASTM B-152
Plating — Tin per ASTM B-545

Metallic Sleeve — Copper per ASTM B-152
Plating — Nickel per QQ-N-290 or Tin per ASTM B-545

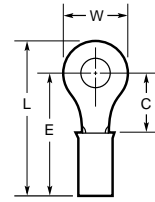

Military Specifications M7928/1

Wire Size Circular Mils [mm ²]	Tongue Material Thickness Max.	Stud Size	Dimensions				Terminal Insulation Color Solid/Stripe	Wire Insulation Diameter Max.	Class	M7928/1 Dash Numbers	Part Numbers			
			W	C Min.	E Max.	L Max.					Loose Piece	Tape Mounted		
26 304 [0.15]	.029 0.74	2 M2	.203 5.16	.211 5.36	.632 16.05	.739 18.77	Yellow/Black	.026-.055 0.66-1.40	1 & 2	1	53078 [†]	—		
		4	.203 5.16	.211 5.36	.632 16.05	.736 18.69	Yellow/Black	.026-.055 0.66-1.40	1 & 2	2	53049 [†]	—		
		6 M3.5	.250 6.35	.243 6.17	.664 16.87	.792 20.12	Yellow/Black	.026-.055 0.66-1.40	1 & 2	3	53050 [†]	—		
		8 M4	.281 7.14	.250 6.35	.671 17.04	.814 20.68	Yellow/Black	.026-.055 0.66-1.40	1 & 2	4	53051 [†]	—		
		10	.312 7.92	.281 7.14	.702 17.83	.863 21.92	Yellow/Black	.026-.055 0.66-1.40	1 & 2	5	53057 [†]	—		
24 475 [0.24]	.029 0.74	2 M2	.203 5.16	.211 5.36	.632 16.05	.739 18.77	Yellow/Blue	.031-.055 0.79-1.40	1 & 2	6	53053 [†]	—		
		4	.203 5.16	.211 5.36	.632 16.05	.736 18.69	Yellow/Blue	.031-.055 0.79-1.40	1 & 2	7	53054 [†]	—		
		6 M3.5	.250 6.35	.243 6.17	.664 16.87	.792 20.12	Yellow/Blue	.031-.055 0.79-1.40	1 & 2	8	53055 [†]	—		
		8 M4	.281 7.14	.250 6.35	.671 17.04	.814 20.68	Yellow/Blue	.031-.055 0.79-1.40	1 & 2	9	53056 [†]	—		
		10	.312 7.92	.281 7.14	.702 17.83	.860 21.84	Yellow/Blue	.031-.055 0.79-1.40	1 & 2	10	53057 [†]	—		
22 754 [0.38]	.033 0.84	4	.218 5.54	.156 3.96	.622 15.80	.734 18.64	Red/Green	.038-.110 0.97-2.79	1 & 2	11	52273*	—		
		6 M3.5	.218 5.54	.156 3.96	.622 15.80	.734 18.64	Red/Green	.038-.110 0.97-2.79	1 & 2	12	2-36149-3*	—		
			.250 6.35	.250 6.35	.716 18.19	.844 21.44	Red/Green	.038-.110 0.97-2.79	$\frac{1 \& 2}{2}$	13	51863-2* —	51863-5		
		8 M4	.312 7.92	.281 7.14	.747 18.97	.906 23.01	Red/Green	.038-.110 0.97-2.79	$\frac{1 \& 2}{2}$	14	1-320551-2* —	1-320551-5		
		1/4 M6	.469 11.91	.437 11.10	.903 22.94	1.140 28.96	Red/Green	.038-.110 0.97-2.79	1 & 2	16	2-320571-3	—		
		5/16 M8	.469 11.91	.437 11.10	.903 22.94	1.140 28.96	Red/Green	.038-.110 0.97-2.79	1 & 2	17	2-320572-2	—		
		3/8	.531 13.49	.546 13.87	1.012 25.70	1.280 32.51	Red/Green	.038-.110 0.97-2.79	1 & 2	18	2-320573-1	—		
		1/2 M12	.713 18.11	.530 13.46	.996 25.30	1.355 34.42	Red/Green	.038-.110 0.97-2.79	1 & 2	19	2-328975-1	—		
		10	.031 0.79	4	.312 7.92	.281 7.14	.747 18.97	.906 23.01	Red/Green	.038-.110 0.97-2.79	$\frac{1 \& 2}{2}$	15	2-36153-3*	—
													—	2-36153-6
20 1,186 [0.60]	.033 0.84	4	.218 5.54	.156 3.96	.622 15.80	.734 18.64	Red/Red	.046-.110 1.17-2.79	1 & 2	20	52273-1*	—		
		6 M3.5	.218 5.54	.156 3.96	.622 15.80	.734 18.64	Red/Red	.046-.110 1.17-2.79	1 & 2	21	2-36149-4*	—		
			.250 6.35	.250 6.35	.716 18.19	.844 21.44	Red/Red	.046-.110 1.17-2.79	$\frac{1 \& 2}{2}$	22	51863-3 —	51863-6		
		8 M4	.312 7.92	.281 7.14	.747 18.97	.906 23.01	Red/Red	.046-.110 1.17-2.79	1 & 2	23	1-320551-3*	—		
		10	.312 7.92	.281 7.14	.747 18.97	.906 23.01	Red/Red	.046-.110 1.17-2.79	$\frac{1 \& 2}{2}$	24	2-36153-4* —	2-36153-8		
		1/4 M6	.469 11.91	.437 11.10	.903 22.94	1.140 28.96	Red/Red	.046-.110 1.17-2.79	1 & 2	25	2-320571-4	—		
		5/16 M8	.469 11.91	.437 11.10	.903 22.94	1.140 28.96	Red/Red	.046-.110 1.17-2.79	1 & 2	26	2-320572-3	—		
		3/8	.531 13.49	.546 13.87	1.012 25.70	1.280 32.51	Red/Red	.046-.110 1.17-2.79	1 & 2	27	2-320573-2	—		
		1/2 M12	.713 18.11	.530 13.46	.996 25.30	1.355 34.42	Red/Red	.046-.110 1.17-2.79	1 & 2	28	2-328975-2	—		

*Available in small packaging quantities.
[†]Must be crimped with 22-18 or 22-16 PIDG (red) Tooling.
Note: "C" dimension applies from edge of metal wire barrel to center of stud hole.

Ring Tongue Terminals — Insulation Restricting (Continued)

Material and Finish

Insulation — Nylon
Terminal Body — Copper per ASTM B-152
Plating — Tin per ASTM B-545

Metallic Sleeve — Copper per ASTM B-152
Plating — Nickel per QQ-N-290 or Tin per ASTM B-545

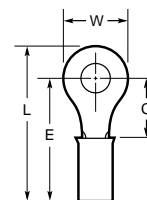

Military Specifications M7928/1 (Continued)

Wire Size Circular Mils [mm ²]	Tongue Material Thickness Max.	Stud Size	Dimensions				Terminal Insulation Color Solid/Stripe	Wire Insulation Diameter Max.	Class	M7928/1 Dash Numbers	Part Numbers	
			W	C Min.	E Max.	L Max.					Loose Piece	Tape Mounted
18 1,900 [0.96]	.033 0.84	4	.218 5.54	.156 3.96	.622 15.80	.734 18.64	Red/White	.056-.110 1.42-2.79	1 & 2	29	52273-2*	—
		6 M3.5	.218 5.54	.156 3.96	.622 15.80	.734 18.64	Red/White	.056-.110 1.42-2.79	1 & 2	30	2-36149-5*	—
			.250 6.35	.250 6.35	.716 18.19	.844 21.44	Red/White	.056-.110 1.42-2.79	$\frac{1 \& 2}{2}$	31	51863-4*	—
		8 M4	.312 7.92	.281 7.14	.747 18.97	.906 23.01	Red/White	.056-.110 1.42-2.79	$\frac{1 \& 2}{2}$	32	1-320551-4*	—
			.312 7.92	.281 7.14	.747 18.97	.906 23.01	Red/White	.056-.110 1.42-2.79	$\frac{1 \& 2}{2}$	33	2-36153-5*	—
		1/4 M6	.469 11.91	.437 11.10	.903 22.94	1.140 28.96	Red/White	.056-.110 1.42-2.79	1 & 2	34	2-320571-5	—
			5/16 M8	.469 11.91	.437 11.10	.903 22.94	1.140 28.96	Red/White	.056-.110 1.42-2.79	1 & 2	35	2-320572-4
		3/8 M12	.531 13.49	.546 13.87	1.012 25.70	1.280 32.51	Red/White	.056-.110 1.42-2.79	1 & 2	36	2-320573-3	—
			.713 18.11	.530 13.46	.996 25.30	1.355 34.42	Red/White	.056-.110 1.42-2.79	1 & 2	37	2-328975-3	—
		16 2,800 [1.42]	.033 0.84	4	.250 6.35	.171 4.34	.637 16.18	.765 19.43	Blue/Blue	.063-.130 1.60-3.30	1 & 2	38
6 M3.5	.250 6.35			.171 4.34	.637 16.18	.765 19.43	Blue/Blue	.063-.130 1.60-3.30	1 & 2	39	2-320561-3*	—
	.312 7.92			.281 7.14	.747 18.97	.906 23.01	Blue/Blue	.063-.130 1.60-3.30	$\frac{1 \& 2}{2}$	40	51864-6*	—
8 M4	.312 7.92			.281 7.14	.747 18.97	.906 23.01	Blue/Blue	.063-.130 1.60-3.30	1 & 2	41	1-51864-0*	—
	.312 7.92			.281 7.14	.747 18.97	.906 23.01	Blue/Blue	.063-.130 1.60-3.30	$\frac{1 \& 2}{2}$	42	51864-7*	—
1/4 M6	.469 11.91			.437 11.10	.903 22.94	1.140 28.96	Blue/Blue	.063-.130 1.60-3.30	1 & 2	43	2-320563-3	—
	5/16 M8			.469 11.91	.437 11.10	.903 22.94	1.140 28.96	Blue/Blue	.063-.130 1.60-3.30	1 & 2	44	2-320575-2
3/8 M12	.531 13.49			.546 13.87	1.012 25.70	1.280 32.51	Blue/Blue	.063-.130 1.60-3.30	1 & 2	45	2-320564-1	—
	.713 18.11			.530 13.46	.996 25.30	1.355 34.42	Blue/Blue	.063-.130 1.60-3.30	1 & 2	46	2-328976-1	—
14 4,234 [2.15]	.033 0.84			4	.250 6.35	.171 4.34	.637 16.18	.765 19.43	Blue/Green	.078-.130 1.98-3.30	1 & 2	47
		6 M3.5	.250 6.35	.171 4.34	.637 16.18	.765 19.43	Blue/Green	.078-.130 1.98-3.30	1 & 2	48	2-320561-4	—
			.312 7.92	.281 7.14	.747 18.97	.906 23.01	Blue/Green	.078-.130 1.98-3.30	1 & 2	49	51864-8*	—
		8 M4	.312 7.92	.281 7.14	.747 18.97	.906 23.01	Blue/Green	.078-.130 1.98-3.30	$\frac{1 \& 2}{2}$	50	1-51864-1*	—
			.312 7.92	.281 7.14	.747 18.97	.906 23.01	Blue/Green	.078-.130 1.98-3.30	$\frac{1 \& 2}{2}$	51	51864-9*	—
		1/4 M6	.469 11.91	.437 11.10	.903 22.94	1.140 28.96	Blue/Green	.078-.130 1.98-3.30	1 & 2	52	2-320563-4	—
			5/16 M8	.469 11.91	.437 11.10	.903 22.94	1.140 28.96	Blue/Green	.078-.130 1.98-3.30	1 & 2	53	2-320575-3
		3/8 M12	.531 13.49	.546 13.87	1.012 25.70	1.280 32.51	Blue/Green	.078-.130 1.98-3.30	1 & 2	54	2-320564-2	—
			.713 18.11	.530 13.46	.996 25.30	1.355 34.42	Blue/Green	.078-.130 1.98-3.30	1 & 2	55	2-328976-2	—

*Available in small packaging quantities.
Note: "C" dimension applies from edge of metal wire barrel to center of stud hole.

Ring Tongue Terminals — Insulation Restricting (Continued)

Material and Finish

Insulation — Nylon
Terminal Body — Copper per ASTM B-152
Plating — Tin per ASTM B-545

Metallic Sleeve — Copper per ASTM B-152
Plating — Nickel per QQ-N-290 or Tin per ASTM B-545

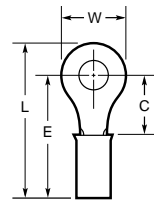

Military Specifications M7928/1 (Continued)

Wire Size Circular Mills [mm ²]	Tongue Material Thickness Max.	Stud Size	Dimensions				Terminal Insulation Color Solid/Stripe	Wire Insulation Diameter Max.	Class	M7928/1 Dash Numbers	Part Numbers			
			W	C Min.	E Max.	L Max.					Loose Piece	Tape Mounted		
12 6,654 [3.37]	.042 1.07	6 M3.5	.375 9.53	.302 7.67	.958 24.33	1.148 29.16	Yellow/Yellow	.095-.200 2.41-5.08	1 & 2	56	2-36161-5	—		
		8 M4	.375 9.53	.302 7.67	.958 24.33	1.148 29.16	Yellow/Yellow	.095-.200 2.41-5.08	1 & 2	57	2-320568-2*	—		
		10	.375 9.53	.302 7.67	.958 24.33	1.148 29.16	Yellow/Yellow	.095-.200 2.41-5.08	1 & 2	58	2-36161-3*	—		
		1/4 M6	.531 13.49	.468 11.89	1.124 28.55	1.392 35.36	Yellow/Yellow	.095-.200 2.41-5.08	1 & 2	59	2-320569-5	—		
		5/16 M8	.531 13.49	.468 11.89	1.124 28.55	1.392 35.36	Yellow/Yellow	.095-.200 2.41-5.08	1 & 2	60	2-320576-2	—		
		3/8	.593 15.06	.531 13.49	1.187 30.15	1.486 37.74	Yellow/Yellow	.095-.200 2.41-5.08	1 & 2	61	2-320577-1	—		
		1/2 M12	.715 18.16	.474 12.04	1.130 28.70	1.490 37.85	Yellow/Yellow	.095-.200 2.41-5.08	2	62	52077-1	—		
		10 12,066 [6.11]	.042 1.07	6 M3.5	.375 9.53	.302 7.67	.958 24.33	1.148 29.16	Yellow/Brown	.119-.200 3.02-5.08	1 & 2	63	2-36161-6	—
				8 M4	.375 9.53	.302 7.67	.958 24.33	1.148 29.16	Yellow/Brown	.119-.200 3.02-5.08	1 & 2	64	2-320568-3* —	— 2-36161-8
				10	.375 9.53	.302 7.67	.958 24.33	1.148 29.16	Yellow/Brown	.119-.200 3.02-5.08	$\frac{1 \& 2}{2}$	65	2-36161-4 —	—
1/4 M6	.531 13.49			.468 11.89	1.124 28.55	1.392 35.36	Yellow/Brown	.119-.200 3.02-5.08	$\frac{1 \& 2}{2}$	66	2-320569-6 —	— 2-320569-8		
5/16 M8	.531 13.49			.468 11.89	1.124 28.55	1.392 35.36	Yellow/Brown	.119-.200 3.02-5.08	1 & 2	67	2-320576-3	—		
3/8	.593 15.06			.531 13.49	1.187 30.15	1.486 37.74	Yellow/Brown	.119-.200 3.02-5.08	1 & 2	68	2-320577-2	—		
1/2 M12	.715 18.16			.474 12.04	1.130 28.70	1.490 37.85	Yellow/Brown	.119-.200 3.02-5.08	2	69	52077-2	—		

*Available in small packaging quantities.
Note: "C" dimension applies from edge of metal wire barrel to center of stud hole.

Rectangular Tongue Terminals

Material and Finish

Insulation — Nylon

Terminal Body and Metallic

Sleeve — Copper per ASTM B-152
except where noted.

Plating — Tin per ASTM B-545

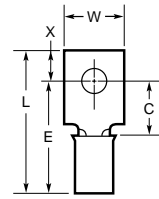

Military Specifications MS17143

Wire Size Circular Mils [mm ²]	Tongue Material Thickness Max.	Stud Size	Dimensions					Terminal Insulation Color	Wire Insulation Diameter Max.	Class	M17143 Dash Numbers	Part Numbers			
			W	C Min.	E Max.	L Max.	X					Loose Piece	Tape Mounted		
22-16 500 [0.26-1.65]	.033 0.84	4	.237 6.02	.237 6.02	.643 16.33	.796 20.22	.143 3.63	Red	.140 3.56	1 & 2	19	2-327968-1	—		
			.237 6.02	.404 10.26	.810 20.57	1.015 25.78	.195 4.95	Red	.140 3.56	1 & 2	16	327962	—		
		5 M3	.277 7.04	.277 7.04	.702 17.83	.855 21.72	.143 3.63	Red	.140 3.56	1 & 2	10	2-327950-1	—		
		6 M3.5	.237 6.02	.404 10.26	.810 20.57	1.015 25.78	.195 4.95	Red	.140 3.56	1 & 2	13	2-327956-1	—		
			.302 7.67	.465 11.81	.872 22.15	1.109 28.17	.227 5.77	Red	.140 3.56	$\frac{1 & 2}{2}$	4	2-327938-1 —	— 2-327938-2		
		8 M4	.302 7.67	.465 11.81	.872 22.15	1.109 28.17	.227 5.77	Red	.140 3.56	$\frac{1 & 2}{2}$	7	327944*	—		
			.390 9.91	.621 15.77	1.039 26.39	1.359 34.52	.310 7.87	Red	.140 3.56	1 & 2	1	327932	—		
		16-14 2,050-5,180 [1.04-2.62]	.033 0.84	4	.237 6.02	.237 6.02	.643 16.33	.796 20.22	.143 3.63	Blue	.150 3.81	1 & 2	20	2-327970-4	—
					.237 6.02	.404 10.26	.810 20.57	1.015 25.78	.195 4.95	Blue	.150 3.81	1 & 2	17	2-327964-4	—
				5 M3	.277 7.04	.277 7.04	.702 17.83	.855 21.72	.143 3.63	Blue	.150 3.81	$\frac{1 & 2}{2}$	11	2-327952-2 —	— 2-327952-6
6 M3.5	.237 6.02			.404 10.26	.810 20.57	1.015 25.78	.195 4.95	Blue	.150 3.81	1 & 2	14	2-327958-4	—		
	.302 7.67			.465 11.81	.872 22.15	1.109 28.17	.227 5.77	Blue	.150 3.81	1 & 2	5	2-327940-4	—		
8 M4	.302 7.67			.465 11.81	.872 22.15	1.109 28.17	.227 5.77	Blue	.150 3.81	1 & 2	8	2-327946-4	—		
	.390 9.91			.621 15.77	1.039 26.39	1.359 34.52	.310 7.87	Blue	.150 3.81	1 & 2	2	2-327934-2	—		
12-10 5,180-13,100 [2.62-6.64]	.042 1.07			4	.237 6.02	.237 6.02	.831 21.11	.984 24.99	.143 3.63	Yellow	.230 5.84	1 & 2	21	327972	—
					.237 6.02	.404 10.26	.998 25.35	1.203 30.56	.195 4.95	Yellow	.230 5.84	1 & 2	18	327966	—
				5 M3	.277 7.04	.277 7.04	.889 22.58	1.042 26.47	.143 3.63	Yellow	.230 5.84	$\frac{1 & 2}{2}$	12	327954 —	— 2-327954-2
		6 M3.5	.237 6.02	.404 10.26	.998 25.35	1.203 30.56	.195 4.95	Yellow	.230 5.84	$\frac{1 & 2}{2}$	15	2-327960-1 —	— 2-327960-2		
			.302 7.67	.465 11.81	1.044 26.52	1.281 32.54	.227 5.77	Yellow	.230 5.84	1 & 2	6	327942	—		
		8 M4	.302 7.67	.465 11.81	1.044 26.52	1.281 32.54	.227 5.77	Yellow	.230 5.84	1 & 2	9	327948	—		
			.390 9.91	.621 15.77	1.211 30.76	1.531 38.89	.310 7.87	Yellow	.230 5.84	1 & 2	3	327936	—		

*Available in small packaging quantities.

Note: "C" dimension applies from edge of metal wire barrel to center of stud hole.

Electronics

Butt Splices

Material and Finish

Insulation Sleeve —
Standard, Step Down Assembly
and Nylon

Radiation Resistant —
Polyvinylidene Fluoride (PVF2)

**Splice Body and Insulation
Support Sleeve** — Copper per ASTM
B-152

Plating — Tin per ASTM B-545

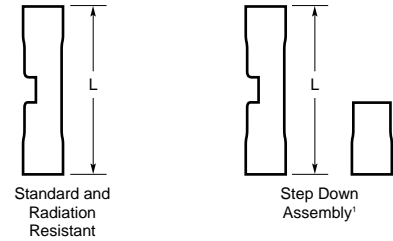

Military Specifications M7928/5

Wire Size Circular Mils ¹ [mm ²]	Style	Dimension L Max.	Splice Insulation Color	Wire Insulation Diameter Max.	Class	M7928/5 Dash Numbers	Part Numbers	
							Loose Piece	Tape Mounted
26-24 ² 238-475 [0.12-0.24]	Standard	.890 22.61	Yellow	.082 2.08	1 & 2	1	323994	—
24-20 320-1,290 [0.16-0.65]		1.035 26.29	Natural	.100 2.54	$\frac{1 \& 2}{2}$	2	323975 —	— 2-323975-3
22-16 ³ 509-3,260 [0.26-1.65]		1.265 32.13	Red	.125 3.18	$\frac{1 \& 2}{2}$	3	320559* —	— 2-320559-4
16-14 2,050-5,180 [1.04-2.62]		1.265 32.13	Blue	.150 3.81	$\frac{1 \& 2}{2}$	4	320562* —	— 2-320562-3
12-10 5,180-13,100 [2.62-6.64]		1.656 42.06	Yellow	.220 5.59	1 & 2	5	320570*	—

*Available in small packaging quantities.

¹ When using two or more wires in either end of a butt splice, the combined cross sectional area must be within the (CMA) circular mil area range listed.

² 26-24 range in accordance with MIL-T-7928.

³ 22-16 splices are 22-18 range in accordance with MIL-T-7928.

Military Specifications M7928/6

Wire Size Circular Mils ¹ [mm ²]	Style	Dimension L Max.	Splice Insulation Color	Wire Insulation Diameter Max.	Class	M7928/6 Dash Numbers	Part Numbers	
							Loose Piece	Tape Mounted
26-24 ² 238-475 [0.12-0.24]	Radiation Resistant	.890 22.61	Natural w/ Yellow Stripes	.082 2.08	1 & 2	1	53546-1	—
24-20 320-1,290 [0.16-0.65]		1.035 26.29	Natural w/ White Stripes	.100 2.54	$\frac{1 \& 2}{2}$	2	53547-1 —	— 53547-2
22-16 ³ 509-3,260 [0.26-1.65]		1.265 32.13	Natural w/ Red Stripes	.125 3.18	$\frac{1 \& 2}{2}$	3	53548-1* —	— 53548-2
16-14 2,050-5,180 [1.04-2.62]		1.265 32.13	Natural w/ Blue Stripes	.150 3.81	1 & 2	4	53549-1*	—

*Available in small packaging quantities.

¹ When using two or more wires in either end of a butt splice, the combined cross sectional area must be within the (CMA) circular mil area range listed.

² 26-24 range in accordance with MIL-T-7928.

³ 22-16 splices are 22-18 range in accordance with MIL-T-7928.

Introduction

Product Facts

- Select items have MIL-T-7928 approval under M7928/4 and /6
- Insulation is polyvinylidene fluoride (PVF₂) for high radiation resistance (to 200 megarads)
- Withstands 4 days of steam/chemical spray washdown which simulates LOCA (loss of coolant accident) conditions
- Temperature range of -85°C to +302°F [-65°C to +150°C]
- Uses AMP standard PIDG and PLASTI-GRIP Terminal tooling
- Color coded for easy wire and tool match
- Covers wide range of wire sizes — AWG 26-2/0 [0.12-70 mm²]
- Tin-plated per MIL-T-10727
- Butt splice for wire sizes — AWG 26-10 [0.12-6 mm²]

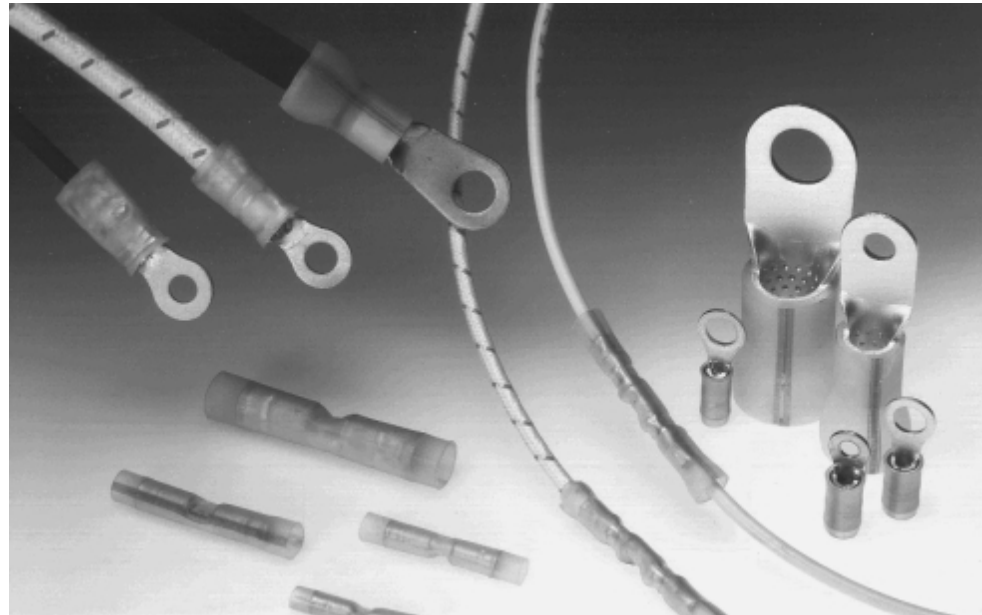

The line of AMP Radiation Resistant/302°F [150°C] Pre-Insulated Terminals and Splices includes terminals and splices of the well-known PIDG terminal designs. Radiation Resistant Terminals are made of fine grade, high conductivity copper with bright tin-plating and feature polyvinylidene fluoride (PVF₂) insulation for high resistance to radiation and solvents. PIDG terminals meet the performance requirements of MIL-T-7928. They are also tested by Tyco Electronics and an independent test facility and have fulfilled all requirements including radiation testing to 200 megarads, operating temperature range from 509°F to 2102°F [265°C to 1150°C] and resistance to steam and various chemical solvents to simulate LOCA (loss of coolant accident) conditions.

These terminals and splices feature the outstanding qualities of standard AMP

terminals such as tapered entry ramps to help better eliminate bent wire strands and insulation support for stronger, more reliable connections. Serrated or dimpled wire barrels provide maximum contact and tensile strength after crimping, and color coded insulation with wire size stamped on the terminal tongue identifies the product and assists in proper terminal-wire match.

AMP Radiation Resistant/302°F [150°C] Terminals are designed and engineered to successfully withstand extreme vibration, shock and structural stresses, and other conditions which can adversely affect the critical circuit requirements in complex equipment.

The matching AMP tooling precisely crimps all terminations. This uniformity increases reliability and also serves as a built-in quality control factor.

Technical Documents

- Instruction Sheets —**
- 408-1559 DAHT's for 26-10 AWG connectors
 - 408-1724 Crimping dies for 8-2/0 AWG connectors

PIDG Terminal Style

Ring Tongue Terminals

Material and Finish

Terminal Body — Copper per QQ-C-576 with tin plating per MIL-T-10727 or gold plating per MIL-G-45204 over nickel per QQ-N-290

Insulation Support Sleeve — Copper per QQ-C-576 with tin plating per MIL-T-10727

Insulation Sleeve — PVF₂, natural color

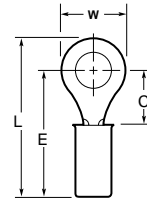

Military Specifications M7928/4

Wire Range AWG	CMA	Tongue Thickness Max.	Wire Insulation Diameter Max.	Stripe Color Code	Stud Size	Dimensions				Class	M7928/4 Dash Numbers	Part Numbers	
						C Min.	W	E Max.	L Max.			Tin Plate Loose	Tape Mounted
26-24	202-509	.029 0.74	.082 2.09	Yellow	2 M2	.211 5.36	.203 5.16	.632 16.05	.736 18.69	1 & 2	143	53400-1	—
					4	.211 5.36	.203 5.16	.632 16.05	.736 18.69	1 & 2	144	53401-1	—
					6 M3.5	.243 6.17	.250 6.35	.664 16.87	.792 20.12	1 & 2	145	53402-1	—
					8 M4	.250 6.35	.281 7.13	.671 17.05	.814 20.68	1 & 2	146	53403-1	—
					10	.281 7.14	.312 7.92	.702 17.83	.861 21.87	1 & 2	147	53404-1	—
22-16	509-3,250	.033 0.84	.125 3.18	Red	4	.156 3.96	.218 5.54	.560 14.23	.672 17.07	1 & 2	148	53405-1	—
					6 M3.5	.156 3.96	.218 5.54	.560 14.23	.672 17.07	1 & 2	101	53406-1	—
						.250 6.35	.250 6.35	.654 16.62	.782 19.87	1 & 2 2	102	53407-1	—
						—	—	—	—	—	—	53407-2	—
					8 M4	.281 7.13	.312 7.91	.685 17.4	.844 21.44	1 & 2 2	149	53408-1	—
						—	—	—	—	—	—	53408-2	—
					10	.281 7.13	.312 7.92	.685 17.4	.844 21.44	1 & 2	103	53409-1	—
					1/4 M6	.437 11.10	.469 11.91	.841 21.36	1.078 27.38	1 & 2 2	150	53410-1	—
						—	—	—	—	—	—	53410-2	—
					5/16 M8	.437 11.10	.469 11.91	.841 21.36	1.078 27.38	1 & 2	104	53411-1	—
3/8	.546 13.87	.531 13.49	.950 24.13	1.218 30.94	1 & 2	105	53412-1	—					
1/2 M12	.530 13.46	.713 18.11	.934 23.72	1.293 32.84	1 & 2	151	53413-1	—					
16-14	2,050-5,180	.033 0.84	.150 3.81	Blue	4	.171 4.34	.250 6.35	.575 14.61	.703 17.86	1 & 2	152	53414-1	—
					6 M3.5	.171 4.34	.250 6.35	.575 14.61	.703 17.86	1 & 2	106	53415-1	—
						.281 7.13	.312 7.92	.685 17.4	.844 21.44	1 & 2 2	107	53416-1	—
						—	—	—	—	—	—	53416-2	—
					8 M4	.281 7.13	.312 7.92	.685 17.4	.844 21.44	1 & 2	153	53417-1	—
					10	.281 7.13	.312 7.92	.685 17.4	.844 21.44	1 & 2 2	108	53418-1	—
						—	—	—	—	—	—	53418-2	—
					1/4 M6	.437 11.09	.469 11.91	.841 21.37	1.078 27.39	1 & 2	154	53419-1	—
					5/16 M8	.437 11.09	.469 11.91	.841 21.37	1.078 27.39	1 & 2	109	53420-1	—
					3/8	.546 13.87	.531 13.49	.950 24.13	1.218 30.94	1 & 2	110	53421-1	—
1/2 M12	.530 13.46	.713 18.11	.934 23.72	1.293 32.84	1 & 2	155	53422-1	—					
12-10	5,180-13,100	.042 1.07	.230 5.84	Yellow	6 M3.5	.302 7.67	.375 9.53	.893 22.69	1.083 27.51	1 & 2	111	53423-1*	—
					8 M4	.302 7.67	.375 9.53	.893 22.69	1.083 27.51	1 & 2 2	156	53424-1*	—
						—	—	—	—	—	—	53424-2	—
					10	.302 7.67	.375 9.53	.893 22.69	1.083 27.51	1 & 2 2	112	53425-1*	—
						—	—	—	—	—	—	53425-2	—
					1/4 M6	.468 11.88	.531 13.48	1.054 26.78	1.322 33.58	1 & 2	157	53426-1*	—
					5/16 M8	.468 11.88	.531 13.48	1.054 26.78	1.322 33.58	1 & 2	113	53427-1*	—
					3/8	.531 13.48	.593 15.06	1.115 28.32	1.414 35.92	1 & 2	114	53428-1	—
					1/2 M12	.474 12.04	.715 18.16	1.054 26.78	1.414 35.92	2	158	53429-1	—

*Braze body

Application Tooling



Long Handle Tool



T-HEAD Tool



Heavy Head Tool

Wire Size Range		Hand Tools		Pneumatic Tools		
AWG	mm ²	Style	Part Number	Heads for 6-26 Single Wire Range	Heads for 6-26 Multi-Wire Range	Dies for 69710-1 ¹ 217200-1 ²
26-24 & 22-16	0.1-0.2 & 0.26-1.65	Long Handle T-HEAD Tool T-HEAD Tool	47386 59250 59300	314270-3	679305-1	47806-2
22-16	0.26-1.65	Long Handle	69151-1**	—	—	—
16-14	1.04-2.62	Long Handle Long Handle T-HEAD Tool	69152-1** 47387 59250	314269-1	679305-1	47807-1
12-10	2.62-6.64	Heavy Head Heavy Head	59239-4 69150-1**	679300-1	679305-1	47808-6

**Maximum tongue width of terminals for use with these dies is .469 [11.91] when used in tool 46110-2.

Flat tongues only.

**For wires with thin wall insulation.

¹69710-1 hand tool

²6-26 Pneumatic Tool Adapter

Introduction

Product Facts

- Designed to accommodate wire gauges 8 AWG through 4/0 AWG
- The first large wire terminal to feature vinyl insulation bonded to the terminal sleeve
- Terminals for wire sizes 8 AWG through 4/0 AWG meet the requirements of MIL-T-7928, Type II, Class 2
- Precision-engineered terminal offering the heavy-duty wire user uniformly high quality connections with permanent insulation support and complete protection against flash over
- Applied in a single effortless operation with the AMP DYNA-CRIMP tool

Why Bonding?

- Terminal insulators must withstand intense crimping pressures necessary for today's high wire-to-terminal contact requirements
- Bonded insulation transmits this pressure evenly to the center of the crimp area
- A positive bond promotes uniform insulation thickness, maintains proper dielectric and tensile values and controls the extrusion of plastic under the crimping dies in the finished connection

The Crimp

- Because both wire and terminal are confined over a greater area during the crimp, a homogeneous mass is achieved
- Crimp is applied gradually to encourage full movement of the wire with minimum extrusion
- Compare this Tyco Electronics method of applying pre-insulated solderless terminals to large gauge wires with the cumbersome mechanical fitting, brazing and manual insulating techniques still used in many plants

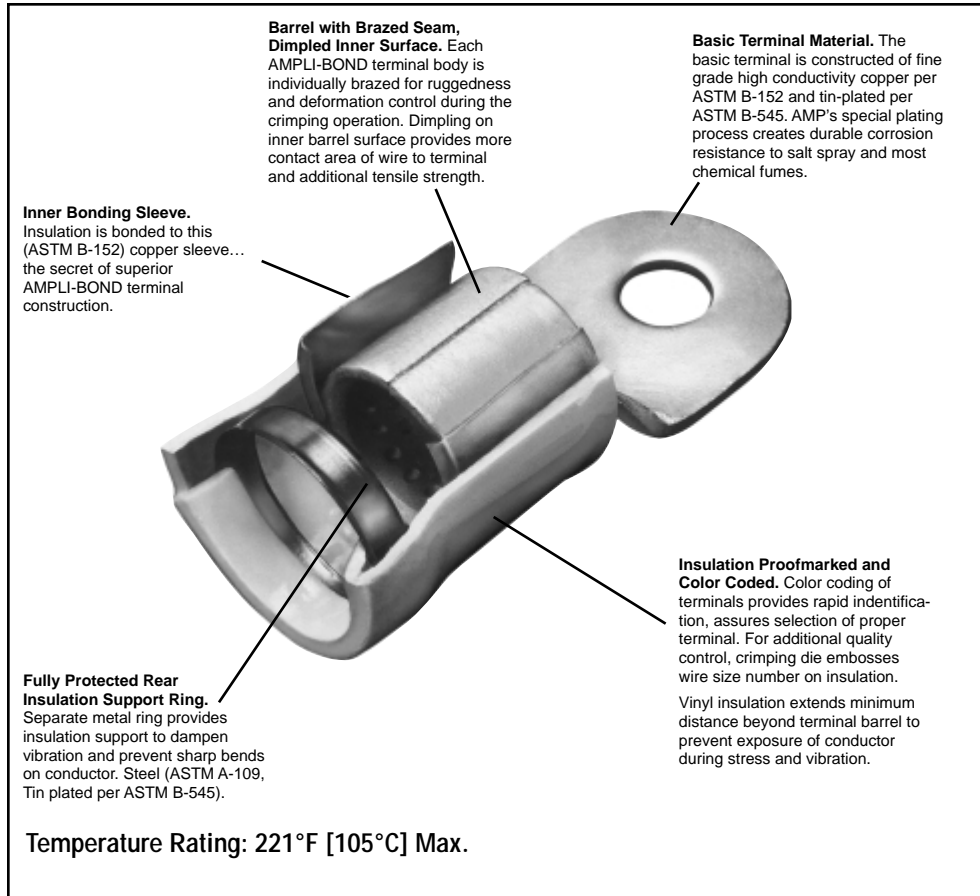

Ring Tongue Terminals

Material and Finish

Insulation — Vinyl
Terminal Body — Copper per ASTM B-152

Insulation Support Ring — Steel per ASTM A-109

Plating — Tin per ASTM B-545 except where noted.

Related Product Data

Application Tooling — page 9045

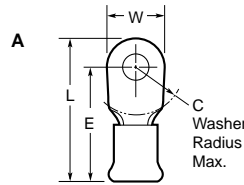

Military Specifications MS25036

Wire Size Circular Mills [mm ²]	Tongue Material Thickness Max.	Stud Size	Style	Dimensions				Terminal Insulation Color	Wire Insulation Diameter Max.	Class	MS25036 Dash Numbers	Part Numbers		
				W	C	E Max.	L Max.					Loose Piece	Tape Mounted	
8 13,100-20,800 [6.64-10.5]	.043 1.09	10	A	.431 10.95	.437 11.10	1.344 34.14	1.562 39.67	Red	.298 7.57	2	115	322128	2-322128-2	
			1/4 M6	A	.478 12.14	.437 11.10	1.344 34.14	1.586 40.28	Red	.298 7.57	2	116	322049	2-322049-5
			5/16 M8	A	.587 14.91	.500 12.70	1.406 35.71	1.702 43.23	Red	.298 7.57	2	117	322003	—
			3/8	A	.587 14.91	.500 12.70	1.406 35.71	1.702 43.23	Red	.298 7.57	2	118	322004	—
6 20,800-33,100 [10.5-16.8]	.048 1.22	10	A	.468 11.89	.421 10.69	1.490 37.85	1.727 43.87	Blue	.377 9.58	2	119	322153	—	
			1/4 M6	A	.500 12.70	.515 13.08	1.599 40.61	1.852 47.04	Blue	.377 9.58	2	120	322051	2-322051-2
			5/16 M8	A	.625 15.88	.515 13.08	1.599 40.61	1.914 48.62	Blue	.377 9.58	2	121	322006*	2-322006-3
			3/8	A	.625 15.88	.515 13.08	1.599 40.61	1.914 48.62	Blue	.377 9.58	2	122	322007	2-322007-2
4 33,100-52,600 [16.8-26.7]	.051 1.30	1/4 M6	A	.546 13.87	.531 13.49	1.632 41.45	1.908 48.46	Yellow	.436 11.07	2	123	322053	—	
			5/16 M8	A	.679 17.25	.531 13.49	1.632 41.45	1.974 50.14	Yellow	.436 11.07	2	124	322010	2-322010-4
			3/8	A	.679 17.25	.531 13.49	1.632 41.45	1.974 50.14	Yellow	.436 11.07	2	125	322011	2-322011-5
2 52,600-83,700 [26.7-42.4]	.060 1.52	1/4 M6	A	.675 17.15	.578 14.68	1.710 43.43	2.050 52.07	Red	.505 12.83	2	126	322125	—	
			3/8	A	.711 18.06	.578 14.68	1.710 43.43	2.068 52.53	Red	.505 12.83	2	127	322055	—
			1/2 M12	A	.855 21.72	.578 14.68	1.710 43.43	2.140 54.36	Red	.505 12.83	2	128	322016	—
1 83,700-119,500 [42.4-60.6]	.073 1.85	1/4 M6	A	.807 20.50	.625 15.88	2.063 52.40	2.469 62.71	Blue	.632 16.05	2	129	322085	—	
			3/8	A	.807 20.50	.625 15.88	2.063 52.40	2.469 62.71	Blue	.632 16.05	2	130	322087	—
			1/2 M12	A	.875 22.23	.625 15.88	2.063 52.40	2.501 63.53	Blue	.632 16.05	2	131	321677	—
1/0 83,700-119,500 [42.4-60.6]	.073 1.85	1/4 M6	A	.807 20.50	.625 15.88	2.063 52.40	2.469 62.71	Blue	.632 16.05	2	132	322085	—	
			3/8	A	.807 20.50	.625 15.88	2.063 52.40	2.469 62.71	Blue	.632 16.05	2	133	322087	—
			1/2 M12	A	.875 22.23	.625 15.88	2.063 52.40	2.501 63.53	Blue	.632 16.05	2	134	321677	—
2/0 119,500-150,500 [60.6-76.3]	.083 2.11	5/16 M8	A	.926 23.52	.625 15.88	2.084 52.93	2.540 64.52	Yellow	.684 17.37	2	135	322089	—	
			3/8	A	.926 23.52	.625 15.88	2.084 52.93	2.540 64.52	Yellow	.684 17.37	2	136	322090	—
			1/2 M12	A	.926 23.52	.625 15.88	2.084 52.93	2.540 64.52	Yellow	.684 17.37	2	137	322092	—
3/0 150,500-190,000 [76.3-96.3]	.094 2.39	3/8	A	1.062 26.97	.625 15.88	2.166 55.02	2.697 68.50	Red	.737 18.72	2	138	322059	—	
			1/2 M12	A	1.062 26.97	.625 15.88	2.166 55.02	2.697 68.50	Red	.737 18.7	2	139	322060	—
4/0 190,000-231,000 [96.3-117]	.105 2.67	3/8	A	1.140 28.96	.625 15.88	2.203 55.96	2.766 70.26	Blue	.799 20.29	2	140	322061	—	
			1/2 M12	A	1.062 26.97	.625 15.88	2.166 55.02	2.697 68.50	Blue	.799 20.29	2	141	322062	—

* Available in small packaging quantities.

† Tyco Electronics recommends #1/0 AWG terminals for #1 AWG application.

Introduction

Product Facts

- Designed to provide insulated terminals and splices for large wire sizes, many of which are used in airborne and ground support applications
- Tested under the procedures stipulated by MIL Spec. MIL-T-7928, they meet and exceed requirements
- Designed and engineered to successfully withstand many vibration, shock and structural stresses, elevated temperatures and other conditions which can adversely affect the circuit requirements in complex air and space flight equipment
- The use of matching AMP tooling for precision crimping which makes all terminations identical
- This uniformity promotes maximum reliability and, coupled with tool die marks on the barrel indicating the wire size and color coding of the insulation sleeve, also serves as a built-in quality control factor
- Pre-insulated with color coded nylon which also acts as insulation support
- Wire size range of terminals is 8 AWG through 4/0 AWG

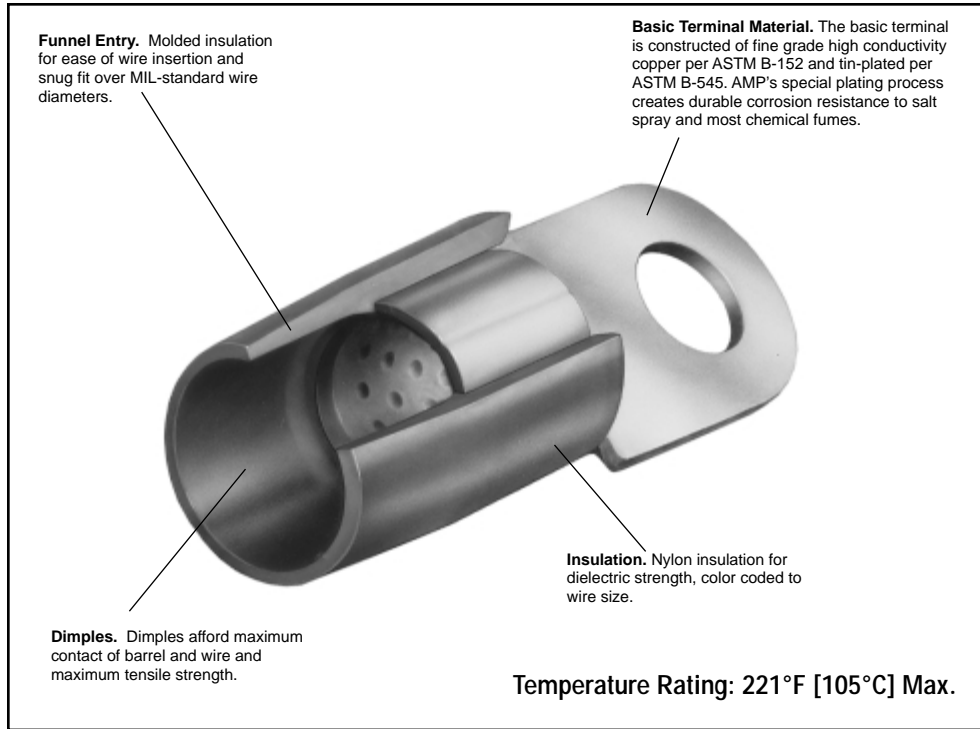

Funnel Entry. Molded insulation for ease of wire insertion and snug fit over MIL-standard wire diameters.

Basic Terminal Material. The basic terminal is constructed of fine grade high conductivity copper per ASTM B-152 and tin-plated per ASTM B-545. AMP's special plating process creates durable corrosion resistance to salt spray and most chemical fumes.

Insulation. Nylon insulation for dielectric strength, color coded to wire size.

Dimples. Dimples afford maximum contact of barrel and wire and maximum tensile strength.

Temperature Rating: 221°F [105°C] Max.

Ring Tongue Terminals

Material and Finish

Insulation — Nylon
 Terminal Body — Copper per
 ASTM B-152
 Plating — Tin per ASTM B-545

Related Product Data

Application Tooling — page 9045

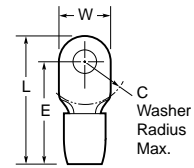

Military Specifications MS25036

Wire Size Circular Mills [mm ²]	Tongue Material Thickness Max.	Stud Size	Dimensions				Terminal Insulation Color	Wire Insulation Diameter Max.	Class	MS25036 Dash Numbers	Part Number Loose Piece
			W	C	E Max.	L Max.					
8 13,100-20,800 [6.64-10.5]	.043 1.09	10	.431 10.95	.437 11.10	1.183 30.05	1.402 35.61	Red	.256 6.50	2	115	324043
		1/4 M6	.478 12.14	.437 11.10	1.183 30.05	1.425 36.20	Red	.256 6.50	2	116	324082
		5/16 M8	.587 14.91	.500 12.70	1.246 31.65	1.542 39.17	Red	.256 6.50	2	117	324044
		3/8	.587 14.91	.500 12.70	1.246 31.65	1.542 39.17	Red	.256 6.50	2	118	324045
6 20,800-33,100 [10.5-16.8]	.048 1.22	10	.468 11.89	.421 10.69	1.338 33.99	1.575 40.01	Blue	.314 7.98	2	119	324046
		1/4 M6	.500 12.70	.515 13.08	1.447 36.75	1.700 43.18	Blue	.314 7.98	2	120	324047
		5/16 M8	.625 15.88	.515 13.08	1.447 36.75	1.762 44.75	Blue	.314 7.98	2	121	324048
		3/8	.625 15.88	.515 13.08	1.447 36.75	1.762 44.75	Blue	.314 7.98	2	122	324049
4 33,100-52,600 [16.8-26.7]	.051 1.30	1/4 M6	.546 13.87	.531 13.49	1.536 39.01	1.812 46.02	Yellow	.382 9.70	2	123	324050
		5/16 M8	.679 17.25	.531 13.49	1.536 39.01	1.878 47.70	Yellow	.382 9.70	2	124	324051
		3/8	.679 17.25	.531 13.49	1.536 39.01	1.878 47.70	Yellow	.382 9.70	2	125	324052*
2 52,600-83,700 [26.7-42.4]	.060 1.52	1/4 M6	.679 17.25	.578 14.68	1.705 43.31	2.045 51.94	Red	.468 11.89	2	126	324053
		3/8	.711 18.06	.578 14.68	1.705 43.31	2.063 52.40	Red	.468 11.89	2	127	324054
		1/2 M12	.855 21.72	.578 14.68	1.705 43.31	2.135 54.23	Red	.468 11.89	2	128	324055
1 ¹ 83,700-119,500 [42.4-60.6]	.073 1.85	1/4 M6	.807 20.50	.625 15.88	2.033 51.64	2.426 61.62	Blue	.580 14.73	2	129	324056
		3/8	.807 20.50	.625 15.88	2.033 51.64	2.426 61.62	Blue	.580 14.73	2	130	324057
		1/2 M12	.875 22.23	.625 15.88	2.017 51.23	2.454 62.33	Blue	.580 14.73	2	131	324058
1/0 83,700-119,500 [42.4-60.6]	.073 1.85	1/4 M6	.807 20.50	.625 15.88	2.033 51.64	2.426 61.62	Blue	.580 14.73	2	132	324113
		3/8	.807 20.50	.625 15.88	2.033 51.64	2.426 61.62	Blue	.580 14.73	2	133	324057
		1/2 M12	.875 22.23	.625 15.88	2.017 51.23	2.454 62.33	Blue	.580 14.73	2	134	324058
2/0 119,500-150,500 [60.6-76.3]	.083 2.11	5/16 M8	.926 23.52	.625 15.88	2.026 51.46	2.416 61.37	Yellow	.610 15.49	2	135	324083
		3/8	.926 23.52	.625 15.88	2.026 51.46	2.416 61.37	Yellow	.610 15.49	2	136	324084
		1/2 M12	.926 23.52	.625 15.88	2.026 51.46	2.416 61.37	Yellow	.610 15.49	2	137	324085
3/0 150,000-190,000 [76.3-96.3]	.094 2.39	3/8	1.082 27.48	.625 15.88	2.294 58.27	2.794 70.97	Red	.680 17.27	2	138	324185
4/0 190,000-231,000 [96.3-117]	.105 2.67	3/8	1.150 29.21	.625 15.88	2.295 58.29	2.858 75.59	Blue	.765 19.43	2	140	324187
		1/2 M12	1.150 29.21	.625 15.88	2.295 58.29	2.858 75.59	Blue	.765 19.43	2	141	324188

* Available in small packaging quantities.

¹ Tyco Electronics recommends #1/0 AWG terminals for #1 AWG application.

Insulated Terminals and Splices — 30 to 10 AWG Wire Range

Description	AMP Wire Range	Tools for Loose Piece Termination					Tools for Tape Mounted Terminations			
		Hand Tools		Pneumatic Tools			Tape Dies for 69875 TAPETRONIC No Applicator Required	Tape Dies for 354500-1 AMP-O-LECTRIC Model "G" Applicator 567200-3	Tape Dies for AMPOMATOR CLS IV* Applicator 687658-1	Tape Dies for 565435-5 AMP-O-LECTRIC Model "K" Applicator 567200-2
		Single Wire Range	Multi-Wire Range	Heads for 6-26 Single Wire Range	Heads for 6-26 Multi-Wire Range	Dies for 69710-1 ³ 217200-1 ⁴				
PIDG Terminals & Splices	30-26	69163—uses 26-22 Terms.	—	—	—	—	—	—	—	—
	26-22	46121 [†]	59275 [†]	314537-1	—	69344	69877	69877	69877	69877
	22-16	47386 [†]	59250 [†] 59824-1 ¹ 58433-3 ²	314270-3	679305-1	47806-2	69872* 59826-1 ¹	69872* 59826-1 ¹	69872* 59826-1 ¹	69872* 59826-1 ¹
	16-14	68343-1 (.250 exp.) 47387	59250 [†] 59824-1 ¹ 58433-3 ²	314269-1	679305-1	47807-1	69873* 59827-1 ¹	69873* 59827-1 ¹	69873* 59827-1 ¹	69873* 59827-1 ¹
	12-10 16-14 HD	59239-4 [†] 59287-2 (.300 exp.)	59824-1 ¹ 58433-3 ²	679300-1	679305-1	47808-6 Std. 47808-5 (.300 exp.)	69874* 69897 (.300 exp.) 59828-1 ¹	69874* 69897 (.300 exp.) 59828-1 ¹	69874* 69897 (.300 exp.) 59828-1 ¹	69874* 69897 (.300 exp.) 59828-1 ¹

[†]Tooling with adjustable insulation crimp.
^{*}Same die set/configuration as in hand tools.
¹TETRA-CRIMP die configuration.
²PRO-CRIMPER II commercial tool not approved for UL applications.
³69710-1 hand tool.
⁴6-26 Pneumatic Tool Adapter

Insulated Terminals and Splices — 8 to 4/0 AWG Wire Range

Description	Wire Size	Hand Tools	Tools for Loose Piece Terminations		
			Dies for Crimp Head 69051 ¹ & Hydraulic Hand Tool 59974-1	Dies for Crimp Head 69066 ¹ & 58422-1 ¹	Head for Pneumatic Hand Tool 69015
AMPLI-BOND Terminals	8	69959	48752-1	47236-1 ²	—
	6	—	48753-1	47237-1 ²	68325-1
	4	—	48754-1	47238-1 ²	—
	2	—	48755-1	47239-1 ²	—
	1/0	—	—	48756-1 47378-1 ²	—
	2/0	—	—	48757-1	—
	3/0	—	—	48758-1	—
	4/0	—	—	48759-1	—
TERMINYL Terminals and Splices	8	—	47820	—	68285-1
	6	—	47821	—	—
	4	—	47822	—	—
	2	—	47823	—	—
	1/0	—	—	47824	—
	2/0	—	—	47825	—
	3/0	—	—	47915	—
	4/0	—	—	47918	—
4 HD	—	—	69463	—	

¹Heads for Power Units 69120-1, 69120-2, or 314979-1.
²Large expansion dies.

Introduction

Tyco Electronics' dependable, economical wire and cable termination products provide solutions for hundreds of wire and cable interconnect requirements. All Raychem wire termination products are housed inside transparent heat-shrinkable insulation sleeves, which provide inspectability and can provide various levels of environmental protection. Most Raychem termination products incorporate a fluxed solder preform, which is essential for a highly controlled soldering process. Other products incorporate controlled crimping or a unique process of combining a twist-on coil with controlled soldering to provide high-reliability joints on the widest variety of conductor types and platings.

SolderSleeve technology ensures high-quality electrical and mechanical performance time after time. Premeasured solder and flux create repeatable, reliable terminations, reducing rejects and field failures. When the SolderSleeve device is heated, the tubing shrinks and the solder preform melts to make a fully insulated, strain-relieved, protected solder connection. Heat-shrinkable tubing provides the benefits of insulation, strain relief, and protection for our controlled crimp products. Many Raychem interconnect products have earned UL recognition or MIL-Spec approval.

Raychem interconnect devices combine high-strength materials with innovative design for consistent, long-life performance. And because the insulation sleeve is transparent, operators can easily inspect the connection.

Raychem shrink-to-fit technology even helps reduce inventory, because one device size will fit a wide range of wire gauges, cable diameters, and component shapes.

Raychem interconnect products are designed for many applications, from simple splices to terminators for sophisticated electronic systems, either sealed or unsealed, and for high- or low-temperature environments.

Typical SolderSleeve Device (illustration of shield terminator concept)

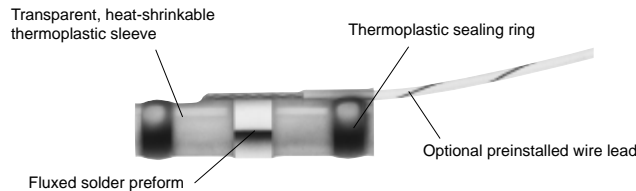

Typical Installation

1. Insert prepared cable



2. Apply heat
Solder preform melts and flows, Installation quality is fully visible through transparent sleeve

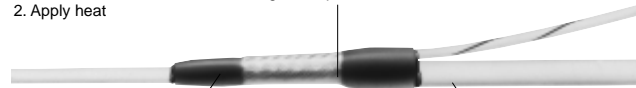

Sleeve shrinks, conforms to cable contours, and provides strain relief

Sealing rings melt to provide environmental protection

METRIC
Dimensions in this section are millimeters over inches

Product Selection

Application Type	Max. Operating Temp.	Connection Type	Product Description	Series	Page Number
Wire-to-wire splicing	125°C [257°F]	Solder	SolderSleeve wire splices	CWT-900X	9050
	150°C [302°F]	Solder	SolderSleeve wire splices	D-110, D-1744	9050
	125°C [257°F]	Coil and solder	SolderGrip closed end connector splices (stub)	SGRP, SGRS	9056
	125°C [257°F]	Crimp	DuraSeal crimp splices	D-406	9062
	150°C [302°F]	Crimp	MiniSeal crimp splices	D-436 (M81824)	9064
Terminals and disconnects	125°C [257°F]	Crimp	DuraSeal crimp terminals and disconnects	B-106	9069
	150°C [302°F]	Coil and solder	SolderGrip terminals	SGRT	9075
Wire termination to pin/post/tab	125°C [257°F]	Solder	SolderSleeve wire terminators	CWT-15XX	9082
	150°C [302°F]	Solder	SolderSleeve wire terminators	D-129, D-141, D-71X	9082
Shield termination	125°C [257°F]	Solder	SolderSleeve shield terminators	CWT-X	9086
	150°C [302°F]	Solder	SolderSleeve shield terminators	S01, S02, M83519, SO63	9086
	175°C [347°F]	Solder	SolderSleeve shield terminators	SO96	9086
Coaxial cable termination	125°C [257°F]	Solder	SolderSleeve coaxial cable terminators	CWT-4XXX	9093
	150°C [302°F]	Solder	SolderSleeve coaxial cable terminators	B-02X, B-04X	9093
	150°C [302°F]	Solder	SolderSleeve PCB/coaxial cable terminators	D-607, B-046	9094
	135°C [275°F]	Solder	RF one-step BNC/TNC connectors	RBD, RTD	7034
Cable-to-cable splicing	150°C [302°F]	Solder/Crimp	SolderShield cable splices	D-150	9098
Shielded contacts	150°C [302°F]	Solder	SolderTacts shielded contacts	D-602	2002
Triax connectors	150°C [302°F]	Solder	Triax discrete connectors	D-621, DK-621	13015
MIL-STD-1553	150°C [302°F]	Solder	Triax discrete connectors	D-621, DK-621	13015
Data bus connectors	150°C [302°F]	Solder	Triax discrete connectors	D-621, DK-621	13015
MIL-STD-1553 In-line couplers	150°C [302°F]	Solder or connectorized	In-line data bus microcoupler	D-500-04	13005
MIL-STD-1533	150°C [302°F]	Connectorized	Data bus box couplers	D-500-025	13011
Triaxial size 8 contacts	150°C [302°F]	Solder	Size 8, triaxial MIL-C-38999 contacts	D-602, DK-602	13015
Data bus cables	150°C [302°F]	Crimp or solder	MIL-STD-1553 B shielded cable	1061X	13003
Data bus terminators	150°C [302°F]	Solder or connectorized	MIL-STD-1553 78° and 3000° terminators	D-621, D-500	13021
Data bus accessories	150°C [302°F]	Solder or mechanical	Dust caps, braid terminators, splices	D-600, D-150	13021

Product Selection (Continued)

Wire to wire splicing	Solder	125°C	SolderSleeve wire splices	CWT-900X	9050
		150°C	SolderSleeve wire splices	D-110, D-1744	9050
	Crimp	125°C	DuraSeal crimp splices	D-406	9062
		150°C	MiniSeal crimp splices	D-436 (M81824)	9064
	Coil and Solder	125°C	SolderGrip closed end connector splices (stub)	SGRP, SGRS	9056
Terminals and disconnects	Crimp	125°C	DuraSeal crimp terminals and disconnects	B-106	9069
	Coil and Solder	150°C	SolderGrip terminals	SGRT	9075
Wire termination to pin/post/tab	Solder	125°C	SolderSleeve wire terminators	CWT-15XX	9082
		150°C	SolderSleeve wire terminators	D-129, D-141, D-71X	9082
Shield termination	Solder	125°C	SolderSleeve shield terminators	CWT-X	9086
		150°C	SolderSleeve shield terminators	S01, S02, M83519, SO63	9086
		175°C	SolderSleeve shield terminators	SO96	9086
Coax cable termination	Solder	125°C	SolderSleeve coaxial cable terminators	CWT-4XXX	9093
		135°C	RF one-step BNC/TNC connector	RBD, RTD	7034
		150°C	SolderSleeve coaxial cable terminators	B-02X/04X	9093
			SolderSleeve PCB/coaxial cable terminators	D-607, B-046	9094
Cable to cable splicing	Solder/Crimp	150°C	SolderShield cable splices	D-150, B-202	9098
Shielded contacts	Solder	150°C	SolderTacts shielded contacts	D-602	2002
MIL-STD-1553B data bus components	Solder	150°C	Data bus couplers, connectors, terminators, accessories	D-500, D-600, D(K)-621	13002

Introduction

Tyco Electronics offers many products for wire-to-wire splicing: Raychem SolderSleeve splicing devices; SolderGrip splices; and DuraSeal and MiniSeal crimp splices. Like all Raychem interconnect products, the wire-to-wire splicing devices are rugged and reliable, yet easy to install.

Designed for applications with temperatures up to 150°C [302°F], products in this section include:

- SolderSleeve splicing devices, which can be used to make sealed or unsealed splices. In a single step, they solder, insulate, encapsulate, and strain-relieve a wide range of wire sizes.
- DuraSeal heat-shrinkable nylon crimp splices are easy to use in factory or repair applications. DuraSeal crimp splices provide watertight sealing and superior protection against corrosion, abrasion, and vibration.
- Small, lightweight, and low-profile MiniSeal high-performance crimp splices, which substantially reduce wire bundle size and weight, are QPL-listed to the MIL-S-81824 specification, and are required by the MIL-W-5088 specification.
- SolderGrip splices, which are closed-end connectors utilizing a spiral copper coil that grips and compresses the conductors and allows a prefluxed solder ring to flow to the center of the splicing area, resulting in a high-reliability, repeatable solder joint.

SolderSleeve Wire Splices

Product Facts

- Transparent polyvinylidene fluoride or polyolefin sleeve provides encapsulation, inspectability, strain relief, and insulation
- Prefluxed solder preform provides a controlled soldering process
- One-piece design makes installation easy and lowers the installed cost
- With one or two wires per end, the NAS 1744 splices meet 75,000 ft [22,000 m] altitude immersion requirement
- Thermochromic temperature indicator in the NAS splices facilitates termination and inspection
- UL and CUL recognized 

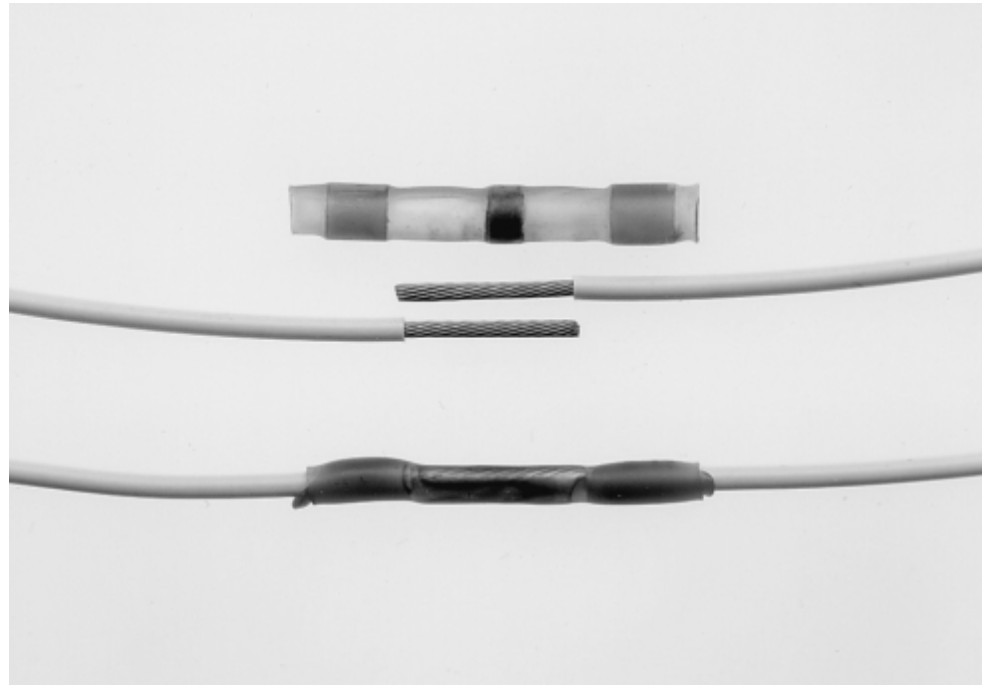

Applications

In-line wire splices.

Product Options

Product Series	Minimum Wire Temperature Rating	Maximum Operating Temperature	Intended Application Environment
CWT	85°C [185°F]	125°C [257°F]	Splashproof
D-110	125°C [257°F]	150°C [302°F]	Splashproof
D-1744 (NAS 1744)	125°C [257°F]	150°C [302°F]	Immersion sealed

Product Selection Process

From the Product Options table above, select the product series appropriate for your application based on the temperature rating and sealing performance required.

If the application has only one size of wire per side and no more than two wires on either side:

1. Determine wire gauge sizes for both sides of splice.
2. Determine number of wires (one or two wires) for each side of splice.
3. Select part numbers from the appropriate table:
 - For CWT series (low temperature): Use Table A on page 9051.

- For D-110 series (splashproof): Use Table B on page 9052.
- For D-1744 series (immersion sealed): Use Table C on page 9053.

If the application has more than one size of wire per side or more than two wires on either side (or if you prefer to work with CMA or mm² sizes):

1. Turn to "CMA/mm² Calculation" on page 9054 and use the workspace there to calculate the total cross section to be spliced.
2. Use Table E on page 9055 to select the sleeve recommended for that cross section.

Notes:

While all combinations listed will provide satisfactory solder joints, the degree of strain relief obtained depends on the outer diameter of the wires being joined. Refer to Table E for the recommended size ranges for the sleeves.

Wires 16 AWG (1.21 mm²) and larger, and wires having more than 19 strands, should be pretinned prior to splicing, to obtain the optimum solder joint quality.

Part selection for wires 26 AWG (0.15 mm²) and smaller is covered on page 9051.

Table A:
CWT Series Selection

Side A:		Side B: Size and Number of Conductors							
Size and Number of Conductors		26 AWG		24 AWG		22 AWG		20 AWG	
		1	2	1	2	1	2	1	2
26 AWG	1	CWT-9001	CWT-9001	CWT-9001	CWT-9001	CWT-9001	CWT-9002	CWT-9002	CWT-9002
	2	CWT-9001	CWT-9001	CWT-9001	CWT-9002	CWT-9001	CWT-9002	CWT-9002	CWT-9002
24 AWG	1	CWT-9001	CWT-9001	CWT-9001	CWT-9001	CWT-9001	CWT-9002	CWT-9002	CWT-9002
	2	CWT-9001	CWT-9002	CWT-9001	CWT-9002	CWT-9002	CWT-9002	CWT-9002	CWT-9002
22 AWG	1	CWT-9001	CWT-9001	CWT-9001	CWT-9002	CWT-9002	CWT-9002	CWT-9002	CWT-9002
	2	CWT-9002	CWT-9002	CWT-9002	CWT-9002	CWT-9002	CWT-9002	CWT-9002	CWT-9003
20 AWG	1	CWT-9002	CWT-9002	CWT-9002	CWT-9002	CWT-9002	CWT-9002	CWT-9002	CWT-9003
	2	CWT-9002	CWT-9002	CWT-9002	CWT-9002	CWT-9002	CWT-9003	CWT-9003	CWT-9003
18 AWG	1	CWT-9002	CWT-9002	CWT-9002	CWT-9002	CWT-9002	CWT-9002	CWT-9002	CWT-9003
	2	CWT-9003	CWT-9003	CWT-9003	CWT-9003	CWT-9003	CWT-9003	CWT-9003	CWT-9003
16 AWG	1	CWT-9002	CWT-9002	CWT-9002	CWT-9002	CWT-9002	CWT-9003	CWT-9003	CWT-9003
	2	CWT-9003	CWT-9003	CWT-9003	CWT-9003	CWT-9003	CWT-9003	CWT-9003	CWT-9003
14 AWG	1	CWT-9003	CWT-9003	CWT-9003	CWT-9003	CWT-9003	CWT-9003	CWT-9003	CWT-9003
	2	CWT-9004	CWT-9004	CWT-9004	CWT-9004	CWT-9004	CWT-9004	CWT-9004	CWT-9004
12 AWG	1	CWT-9003	CWT-9003	CWT-9003	CWT-9003	CWT-9003	CWT-9003	CWT-9003	CWT-9004
	2	CWT-9005	CWT-9005	CWT-9005	CWT-9005	CWT-9005	CWT-9005	CWT-9005	CWT-9005
10 AWG	1	CWT-9005	CWT-9005	CWT-9005	CWT-9005	CWT-9005	CWT-9005	CWT-9005	CWT-9005

Side A:		Side B: Size and Number of Conductors								
Size and Number of Conductors		18 AWG		16 AWG		14 AWG		12 AWG		10 AWG
		1	2	1	2	1	2	1	2	1
26 AWG	1	CWT-9002	CWT-9003	CWT-9002	CWT-9003	CWT-9003	CWT-9004	CWT-9003	CWT-9005	CWT-9005
	2	CWT-9002	CWT-9003	CWT-9002	CWT-9003	CWT-9003	CWT-9004	CWT-9003	CWT-9005	CWT-9005
24 AWG	1	CWT-9002	CWT-9003	CWT-9002	CWT-9003	CWT-9003	CWT-9004	CWT-9003	CWT-9005	CWT-9005
	2	CWT-9002	CWT-9003	CWT-9002	CWT-9003	CWT-9003	CWT-9004	CWT-9003	CWT-9005	CWT-9005
22 AWG	1	CWT-9002	CWT-9003	CWT-9002	CWT-9003	CWT-9003	CWT-9004	CWT-9003	CWT-9005	CWT-9005
	2	CWT-9002	CWT-9003	CWT-9003	CWT-9003	CWT-9003	CWT-9004	CWT-9003	CWT-9005	CWT-9005
20 AWG	1	CWT-9002	CWT-9003	CWT-9003	CWT-9003	CWT-9003	CWT-9004	CWT-9003	CWT-9005	CWT-9005
	2	CWT-9003	CWT-9003	CWT-9003	CWT-9003	CWT-9003	CWT-9004	CWT-9004	CWT-9005	CWT-9005
18 AWG	1	CWT-9003	CWT-9003	CWT-9003	CWT-9003	CWT-9003	CWT-9004	CWT-9004	CWT-9005	CWT-9005
	2	CWT-9003	CWT-9003	CWT-9003	CWT-9004	CWT-9003	CWT-9004	CWT-9004	CWT-9005	CWT-9005
16 AWG	1	CWT-9003	CWT-9003	CWT-9003	CWT-9003	CWT-9003	CWT-9004	CWT-9004	CWT-9005	CWT-9005
	2	CWT-9003	CWT-9004	CWT-9003	CWT-9004	CWT-9004	CWT-9005	CWT-9004	CWT-9005	CWT-9005
14 AWG	1	CWT-9003	CWT-9003	CWT-9003	CWT-9004	CWT-9003	CWT-9004	CWT-9004	CWT-9005	CWT-9005
	2	CWT-9004	CWT-9004	CWT-9004	CWT-9005	CWT-9004	CWT-9005	CWT-9005	CWT-9005	CWT-9005
12 AWG	1	CWT-9004	CWT-9004	CWT-9004	CWT-9004	CWT-9004	CWT-9005	CWT-9004	CWT-9005	CWT-9005
	2	CWT-9005	CWT-9005	CWT-9005	CWT-9005	CWT-9005	CWT-9005	CWT-9005	CWT-9005	CWT-9005
10 AWG	1	CWT-9005	CWT-9005	CWT-9005	CWT-9005	CWT-9005	CWT-9005	CWT-9005	CWT-9005	CWT-9005

Table B:
D-110 Series Selection

Side A:		Side B: Size and Number of Conductors							
Size and Number of Conductors		26 AWG		24 AWG		22 AWG		20 AWG	
		1	2	1	2	1	2	1	2
26 AWG	1	D-110-35	D-110-35	D-110-35	D-110-35	D-110-35	D-110-41	D-110-41	D-110-41
	2	D-110-35	D-110-35	D-110-35	D-110-41	D-110-35	D-110-41	D-110-41	D-110-41
24 AWG	1	D-110-35	D-110-35	D-110-35	D-110-35	D-110-35	D-110-41	D-110-41	D-110-41
	2	D-110-35	D-110-41	D-110-35	D-110-41	D-110-41	D-110-41	D-110-41	D-110-41
22 AWG	1	D-110-35	D-110-35	D-110-35	D-110-41	D-110-41	D-110-41	D-110-41	D-110-41
	2	D-110-41	D-110-41	D-110-41	D-110-41	D-110-41	D-110-41	D-110-41	D-110-0181
20 AWG	1	D-110-41	D-110-41	D-110-41	D-110-41	D-110-41	D-110-41	D-110-41	D-110-0181
	2	D-110-41	D-110-41	D-110-41	D-110-41	D-110-41	D-110-0181	D-110-0181	D-110-0181
18 AWG	1	D-110-41	D-110-41	D-110-41	D-110-41	D-110-41	D-110-41	D-110-41	D-110-0181
	2	D-110-0181	D-110-0181	D-110-0181	D-110-0181	D-110-0181	D-110-0101	D-110-0101	D-110-0101
16 AWG	1	D-110-41	D-110-41	D-110-41	D-110-41	D-110-41	D-110-0181	D-110-0181	D-110-0181
	2	D-110-0101	D-110-0101	D-110-0101	D-110-0101	D-110-0181	D-110-0101	D-110-0101	D-110-0101
14 AWG	1	D-110-0181	D-110-0181	D-110-0181	D-110-0181	D-110-0181	D-110-0101	D-110-0101	D-110-0101
	2	D-110-0101	D-110-0101	D-110-0101	D-110-0101	D-110-0101	D-110-0090	D-110-0101	D-110-0090
12 AWG	1	D-110-0101	D-110-0101	D-110-0101	D-110-0101	D-110-0101	D-110-0101	D-110-0101	D-110-0101
	2	D-110-0090	D-110-0090	D-110-0090	D-110-0090	D-110-0090	D-110-0090	D-110-0090	D-110-0090
10 AWG	1	D-110-0090	D-110-0090	D-110-0090	D-110-0090	D-110-0090	D-110-0083	D-110-0083	D-110-0083

Side A:		Side B: Size and Number of Conductors								
Size and Number of Conductors		18 AWG		16 AWG		14 AWG		12 AWG		10 AWG
		1	2	1	2	1	2	1	2	1
26 AWG	1	D-110-41	D-110-0181	D-110-41	D-110-0101	D-110-0181	D-110-0101	D-110-0101	D-110-0101	D-110-0090
	2	D-110-41	D-110-0181	D-110-41	D-110-0101	D-110-0181	D-110-0101	D-110-0101	D-110-0101	D-110-0090
24 AWG	1	D-110-41	D-110-0181	D-110-41	D-110-0101	D-110-0181	D-110-0101	D-110-0101	D-110-0101	D-110-0090
	2	D-110-41	D-110-0181	D-110-41	D-110-0101	D-110-0181	D-110-0101	D-110-0101	D-110-0101	D-110-0090
22 AWG	1	D-110-41	D-110-0181	D-110-41	D-110-0181	D-110-0181	D-110-0101	D-110-0101	D-110-0101	D-110-0090
	2	D-110-41	D-110-0101	D-110-0181	D-110-0101	D-110-0101	D-110-0090	D-110-0101	D-110-0101	D-110-0090
20 AWG	1	D-110-41	D-110-0101	D-110-0181	D-110-0101	D-110-0101	D-110-0101	D-110-0101	D-110-0101	D-110-0090
	2	D-110-0181	D-110-0101	D-110-0181	D-110-0101	D-110-0101	D-110-0090	D-110-0101	D-110-0101	D-110-0090
18 AWG	1	D-110-0181	D-110-0101	D-110-0181	D-110-0101	D-110-0101	D-110-0090	D-110-0101	D-110-0101	D-110-0090
	2	D-110-0101	D-110-0101	D-110-0101	D-110-0101	D-110-0101	D-110-0090	D-110-0090	D-110-0090	D-110-0083
16 AWG	1	D-110-0181	D-110-0101	D-110-0181	D-110-0101	D-110-0101	D-110-0090	D-110-0101	D-110-0101	D-110-0090
	2	D-110-0101	D-110-0101	D-110-0101	D-110-0090	D-110-0101	D-110-0090	D-110-0090	D-110-0083	D-110-0083
14 AWG	1	D-110-0101	D-110-0101	D-110-0101	D-110-0101	D-110-0101	D-110-0090	D-110-0090	D-110-0090	D-110-0083
	2	D-110-0090	D-110-0090	D-110-0090	D-110-0090	D-110-0090	D-110-0090	D-110-0090	D-110-0083	D-110-0083
12 AWG	1	D-110-0101	D-110-0090	D-110-0101	D-110-0090	D-110-0090	D-110-0090	D-110-0090	D-110-0083	D-110-0083
	2	D-110-0090	D-110-0090	D-110-0090	D-110-0083	D-110-0090	D-110-0083	D-110-0083	D-110-0083	D-110-0083
10 AWG	1	D-110-0083	D-110-0083	D-110-0083	D-110-0083	D-110-0083	D-110-0083	D-110-0083	D-110-0083	D-110-0083

Fine Wire Splices 26 AWG (0.15 mm²) and Smaller

Part No.	Inside Diameter		
	As Supplied*	Fully Recovered**	Length***
D-110-0071	0.9 [0.035]	0.6 [0.025]	4.7 [0.185]
D-110-0213	0.9 [0.035]	0.6 [0.025]	4.2 [0.165]
D-110-0214	0.6 [0.025]	0.3 [0.013]	6.3 [0.250]
D-110-0217	1.0 [0.040]	0.6 [0.025]	9.1 [0.360]
D-110-40	0.6 [0.025]	0.5 [0.021]	5.1 [0.200]

Note: Micro SolderSleeve terminations are used for splicing wires smaller than 26 AWG [0.15 mm²].
 *Minimum. Wire insulation must be smaller than this.
 **Maximum. Wire insulation and combined conductor diameters must be greater than this.
 ***Nominal. Wire strip length must be approximately one-half of this.

Table C:
D-1744 Series Selection

Side A:		Side B: Size and Number of Conductors							
Size and Number of Conductors		26 AWG		24 AWG		22 AWG		20 AWG	
		1	2	1	2	1	2	1	2
26 AWG	1	D-1744-01	D-1744-01	D-1744-01	D-1744-01	D-1744-01	D-1744-01	D-1744-01	D-1744-02
	2	D-1744-01	D-1744-01	D-1744-01	D-1744-01	D-1744-01	D-1744-02	D-1744-01	D-1744-02
24 AWG	1	D-1744-01	D-1744-01	D-1744-01	D-1744-01	D-1744-01	D-1744-01	D-1744-01	D-1744-02
	2	D-1744-01	D-1744-01	D-1744-01	D-1744-01	D-1744-01	D-1744-02	D-1744-02	D-1744-02
22 AWG	1	D-1744-01	D-1744-01	D-1744-01	D-1744-01	D-1744-01	D-1744-02	D-1744-01	D-1744-02
	2	D-1744-01	D-1744-02	D-1744-01	D-1744-02	D-1744-02	D-1744-02	D-1744-02	D-1744-02
20 AWG	1	D-1744-01	D-1744-01	D-1744-01	D-1744-02	D-1744-01	D-1744-02	D-1744-02	D-1744-02
	2	D-1744-02	D-1744-02	D-1744-02	D-1744-02	D-1744-02	D-1744-02	D-1744-02	D-1744-03
18 AWG	1	D-1744-02	D-1744-02	D-1744-02	D-1744-02	D-1744-02	D-1744-02	D-1744-02	D-1744-03
	2	D-1744-03	D-1744-03	D-1744-03	D-1744-03	D-1744-03	D-1744-03	D-1744-03	D-1744-03
16 AWG	1	D-1744-02	D-1744-02	D-1744-02	D-1744-02	D-1744-02	D-1744-02	D-1744-02	D-1744-03
	2	D-1744-03	D-1744-03	D-1744-03	D-1744-03	D-1744-03	D-1744-03	D-1744-03	D-1744-03
14 AWG	1	D-1744-03	D-1744-03	D-1744-03	D-1744-03	D-1744-03	D-1744-03	D-1744-03	D-1744-03
	2	D-1744-03	D-1744-03	D-1744-03	D-1744-03	D-1744-03	D-1744-03	D-1744-03	D-1744-04
12 AWG	1	D-1744-03	D-1744-03	D-1744-03	D-1744-03	D-1744-03	D-1744-03	D-1744-04	D-1744-04
	2	D-1744-04	D-1744-04	D-1744-04	—	D-1744-04	—	—	—

Side A:		Side B: Size and Number of Conductors							
Size and Number of Conductors		18 AWG		16 AWG		14 AWG		12 AWG	
		1	2	1	2	1	2	1	2
26 AWG	1	D-1744-02	D-1744-03	D-1744-02	D-1744-03	D-1744-03	D-1744-03	D-1744-03	D-1744-04
	2	D-1744-02	D-1744-03	D-1744-02	D-1744-03	D-1744-03	D-1744-03	D-1744-03	D-1744-04
24 AWG	1	D-1744-02	D-1744-03	D-1744-02	D-1744-03	D-1744-03	D-1744-03	D-1744-03	D-1744-04
	2	D-1744-02	D-1744-03	D-1744-02	D-1744-03	D-1744-03	D-1744-03	D-1744-03	—
22 AWG	1	D-1744-02	D-1744-03	D-1744-02	D-1744-03	D-1744-03	D-1744-03	D-1744-03	D-1744-04
	2	D-1744-02	D-1744-03	D-1744-02	D-1744-03	D-1744-03	D-1744-03	D-1744-03	—
20 AWG	1	D-1744-02	D-1744-03	D-1744-02	D-1744-03	D-1744-03	D-1744-03	D-1744-03	D-1744-04
	2	D-1744-03	D-1744-03	D-1744-03	D-1744-03	D-1744-03	D-1744-04	D-1744-04	—
18 AWG	1	D-1744-02	D-1744-03	D-1744-03	D-1744-03	D-1744-03	D-1744-03	D-1744-03	—
	2	D-1744-03	D-1744-03	D-1744-03	D-1744-03	D-1744-03	D-1744-04	D-1744-03	—
16 AWG	1	D-1744-03	D-1744-03	D-1744-03	D-1744-03	D-1744-03	D-1744-04	D-1744-03	—
	2	D-1744-03	D-1744-03	D-1744-03	D-1744-03	D-1744-03	D-1744-04	D-1744-04	—
14 AWG	1	D-1744-03	D-1744-03	D-1744-03	D-1744-03	D-1744-03	D-1744-03	D-1744-03	—
	2	D-1744-03	D-1744-04	D-1744-04	D-1744-04	D-1744-04	—	—	—
12 AWG	1	D-1744-03	D-1744-03	D-1744-03	D-1744-04	D-1744-03	—	D-1744-04	—

CMA/mm² Calculation

SolderSleeve Wire Splices (Continued)

To calculate the total circular mil or mm² area of the conductors to be terminated in a single splice, follow these steps:

1. Choose either CMA or mm² as your unit of measure for selection purposes and continue to use it for all your selection criteria.
2. In the workspace below, list the CMA or mm² for each conductor that will go into the same splice. (To assist you, Table D on this page provides the CMA of typical conductors.)
3. Add together the values listed in the workspace below to obtain the total area.
4. From Table E on the next page, select the part number recommended for the total CMA or mm² you have calculated.
5. Refer to the examples on this page for further clarification.

Wire Number	CMA	mm ²	
1	_____	_____	
2	_____	_____	
3	_____	_____	
4	_____	_____	
5	_____	_____	
Total	_____	_____	Part Number: _____

CMA/mm² Examples

One-to-One Wire Splice

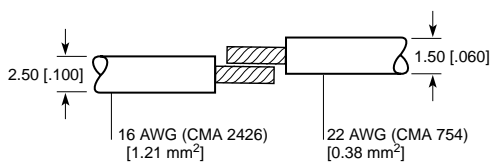

Total CMA = 3180
Total mm² = 1.59

Correct part number selection from Table E (based on CMA/mm² and nominal jacket wire OD) = CWT-9002 or D-110-41 or D-1744-02.

Multiwire Splice

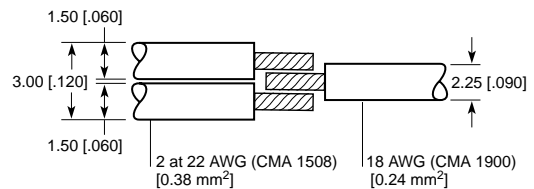

Total CMA = 3408
Total mm² = 1.71

Correct part number selection from Table E (based on CMA/mm² and nominal jacket wire OD) = CWT-9003 or D-110-0181 or D-1744-03.

Table D.

CMA of Typical AWG Conductors

AWG	28	26	24	22	20	18	16	14	12
CMA	177	304	475	754	1216	1900	2426	3831	5874
mm ²	0.09	0.15	0.24	0.38	0.61	0.95	1.21	1.92	2.94

Installation Requirements

For proper installation of these devices the correct heating tool and reflector attachment must be used. Any one of the following Raychem heating tools is recommended:

- HL1802E
- IR-1759 MiniRay
- AA-400 Super Heater
- CV-1981

Refer to Raychem installation procedure RPIP 850-00 for detailed instructions and recommended reflector attachments. You will find ordering information for these tools on pages 9102-9109.

**Table E:
Multiwire Splice Selection**

Product Series	Wire Jacket OD		CMA Combined Total		mm ² Combined Total	
	Min.	Max.	Min.	Max.	Min.	Max.
CWT-9001/D-110-35/D-1744-01	.76 [0.03]	1.5 [0.06]	450	1500	0.2	.75
CWT-9002/D-110-41/D-1744-02	1.0 [0.04]	2.8 [0.11]	1250	4000	0.6	2.0
CWT-9003/D-110-0181/D-1744-03	2.0 [0.08]	4.4 [0.17]	3600	5000	1.8	2.5
CWT-9004/D-110-0101/D-1744-04	3.0 [0.12]	5.8 [0.22]	4800	9000	2.4	4.5
CWT-9005/D-110-0090/D-1744-04	4.0 [0.16]	7.0 [0.27]	8500	16200	4.2	8.1
CWT-9005/D-110-0083	4.0 [0.16]	8.6 [0.34]	16200	25000	8.1	12.5

Product Characteristics

Material	
Insulation (D-110, D-1744)	Radiation-crosslinked, heat-shrinkable polyvinylidene fluoride
Insulation (CWT)	Radiation-crosslinked, heat-shrinkable polyolefin
Solder and flux (D-110, D-1744)	Solder: Sn63 Pb37 Flux: ROL1 per ANSI-J-004 (RMA flux)
Solder and flux (CWT)	Solder: Sn50 Pb32 Cd18 Flux: ROM1 per ASNS-J-004 (RA flux)
Meltable inserts (CWT, D-1744)	Meltable thermoplastic
Typical Performance	
Voltage drop	2.0 mV
Tensile strength	Exceeds strength of conductor
Dielectric strength	2.0 kV
Temperature rating (CWT)	-55°C to +125°C [-67°F to +257°F]
Temperature rating (D-110, D-1744)	-55°C to +150°C [-67°F to +302°F]
Insulation resistance	1000 megohms

Specifications/Approvals

Series	Agency	Raychem
CWT	UL E87681	D-5023
D-110	UL E87681	RT-1404
D-1744	NAS-1744	RT-1404

Product Facts

- Soldered connection
- Electrical insulation
- Sealed for immersion (SGRS)
- Excellent strain relief
- Simple installation

SolderGrip Closed End Connector Splices

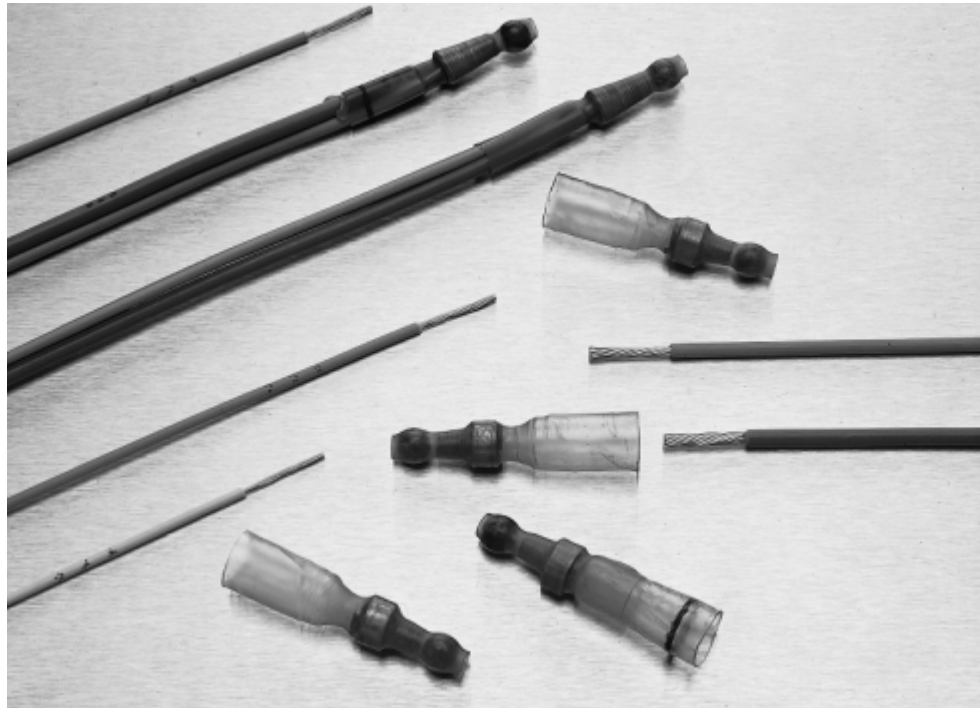

Applications

SolderGrip heat-shrinkable solder-type closed-end connectors are designed for electrical termination of multiple-wire combinations. They provide a reliable alternative to crimping, welding, or conventional twist-on-style closed-end connectors.

Their unique combination of wire fixturing and controlled-soldering technology provides dependable electrical termination of multiple wire combinations.

SolderGrip terminators consist of a heat-shrinkable thermoplastic sleeve containing a spiral-wound copper insert. The insert is fitted with a prefluxed solder band.

This innovation design allows SolderGrip products to reliably terminate as many as 10 wires of different sizes and types in a single device.

The capability of SolderGrip terminators encompasses single or multistranded, bare or tinned copper wires with low- or high-temperature insulation.

The termination is environmentally protected and strain relieved.

SolderGrip splice terminators are color-coded for easy identification.

Product Options

Product Series	Environmental Protection	Max. Operating Temp.
SGRP	Splashproof	125°C [257°F]
SGRS	Sealed	125°C [257°F]

SolderGrip Closed End Connector Splices (Continued)

Product Selection Process

1. From the Product Options table on the previous page, select the product series appropriate for your application.
2. Determine the wire combination (number of wires and size) of the wire bundle you wish to splice.
3. Use Table C (page 9059) to select the correct connector for AWG wire combinations.* For mm² wire combinations use Table A to select a SolderGrip part number.

Example: For connecting a bundle with one 12 AWG wire (1 #12) and two 14 AWG wires (+2 #14), you need an SGRP-4 connector. For sealed parts, select the SGRS series.

*If the wire combination is not listed in Table C, use the CMA (mm²) method of determining wire bundle size (see "CMA/mm² Calculation" on page 9058). Using Table B (page 9058), select the smallest size connector that will fit your total wire CMA (mm²) value.

4. Verify that the wire bundle (with wire insulation) does not exceed the maximum diameter allowed for the connector you selected. Simply check the bundle's diameter against the maximum diameter that Table A (below) lists for that part.
5. Verify that the total amperage to be applied does not exceed the maximum amp rating for the part as specified in Table A.

Insulated Closed-End Connectors (SGRP series)

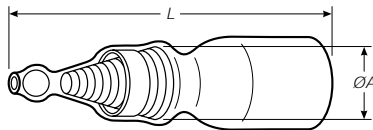

Insulated and Sealed Closed-End Connectors (SGRS series)

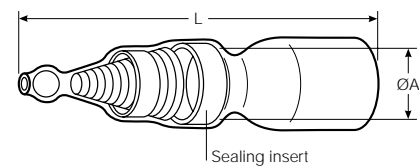

Table A - Product Dimensions and Part Number Descriptions

Part No.	Color Code	Product Dimensions (Min.)			Part No.	Color Code	Product Dimensions (Min.)		
		L	ØA	Wire Range (Min.-Max.) CMA/mm ²			L	ØA	Wire Range (Min.-Max.) CMA/mm ²
SGRP-1	Green	1.370 [34.8]	.120 [2.9]	1400 - 4800 [0.7 - 2.4]	SGRS-1	Green	1.370 [34.8]	0.130 [3.4]	1400 - 4800 [0.7 - 2.4]
SGRP-2	Red	1.350 [34.2]	.150 [3.7]	4000 - 8000 [2.0 - 4.0]	SGRS-2	Red	1.350 [34.2]	0.190 [4.8]	4000 - 8000 [2.0 - 4.0]
SGRP-3	Blue	1.610 [41.0]	.200 [5.1]	7000 - 16000 [3.5 - 8.0]	SGRS-3	Blue	1.650 [42.0]	0.290 [7.3]	7000 - 16000 [3.5 - 8.0]
SGRP-4	Yellow	1.650 [42.0]	.270 [6.8]	15000 - 24000 [7.5 - 12.0]	SGRS-4	Yellow	1.630 [41.5]	0.360 [9.1]	15000 - 24000 [7.5 - 12.0]

SolderGrip Closed End Connector Splices (Continued)

CMA/mm² Calculation

To calculate the total circular mil or mm² area of the wire bundle to be terminated, follow these steps:

1. Choose either CMA or mm² as your unit of measure for selection purposes and continue to use it for all your selection criteria. (Both measures provide the same results.)
2. In the workspace below, list the CMA or mm² for each conductor in the bundle. (Table B provides the CMA of typical conductors.)
3. Add together the values listed in the workspace below to obtain the total area.
4. Use Table A to select the smallest terminator that will fit the total CMA (mm²).

Wire Number	CMA	mm ²	
1	_____	_____	
2	_____	_____	
3	_____	_____	
4	_____	_____	
5	_____	_____	
6	_____	_____	
7	_____	_____	
8	_____	_____	
9	_____	_____	
10	_____	_____	
Total	_____	_____	Solder Grip Part No. _____

CMA/mm² Example

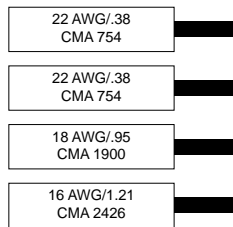

Total CMA = 5834
 Total mm² = 2.92
 Correct part number (based on CMA of 5834 or mm² of 2.92): SGRP-2or SGRS-2

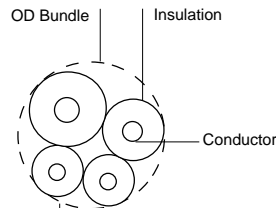

Bundle diameter must not exceed 6.0 mm (0.24 in) for SGRP-2 or 4.5 in (0.18 mm) for SGRS-2.

Table B. CMA of Typical Copper Conductors

AWG	30	28	26	24	22	20	18	16	14	12	10	8
CMA	112	177	304	475	754	1216	1900	2426	3831	5874	9354	16983
mm ²	0.05	0.09	0.15	0.24	0.38	0.61	0.95	1.21	1.92	2.94	4.74	8.61

SolderGrip Closed End Connector Splices (Continued)

Table C. SolderGrip Wire Combinations

Wire Combinations	Splash-proof	Sealed	Wire Combinations	Splash-proof	Sealed	Wire Combinations	Splash-proof	Sealed
1 # 8 + 1 # 12	SGRP-4	SGRS-4	1 # 14 + 3 # 20	SGRP-2	SGRS-2	2 # 16 + 1 # 18 + 3 # 20	SGRP-3	SGRS-3
1 # 8 + 1 # 16	SGRP-4	SGRS-4	1 # 14 + 4 # 20	SGRP-3	SGRS-3	2 # 16 + 1 # 18 + 2 # 20	SGRP-3	SGRS-3
2 # 8 + 2 # 16	SGRP-4	SGRS-4	1 # 14 + 1 # 18	SGRP-2	SGRS-2	2 # 16 + 1 # 18 + 1 # 20	SGRP-2	SGRS-2
1 # 8 + 1 # 14	SGRP-4	SGRS-4	1 # 14 + 1 # 18 + 1 # 20	SGRP-2	SGRS-2	2 # 16 + 1 # 18	SGRP-2	SGRS-2
1 # 8 + 1 # 14 + 1 # 16	SGRP-4	SGRS-4	1 # 14 + 2 # 18	SGRP-2	SGRS-2	2 # 16 + 4 # 20	SGRP-3	SGRS-3
1 # 10 + 1 # 18	SGRP-3	SGRS-3	1 # 14 + 3 # 18	SGRP-3	SGRS-3	2 # 16 + 3 # 20	SGRP-3	SGRS-3
1 # 10 + 2 # 18	SGRP-3	SGRS-3	1 # 14 + 4 # 18	SGRP-3	SGRS-3	2 # 16 + 2 # 20	SGRP-2	SGRS-2
1 # 10 + 3 # 18	SGRP-3	SGRS-3	1 # 14 + 5 # 18	SGRP-3	SGRS-3	2 # 16 + 1 # 20	SGRP-2	SGRS-2
1 # 10 + 1 # 16	SGRP-3	SGRS-3	1 # 14 + 1 # 16	SGRP-2	SGRS-3	2 # 16	SGRP-2	SGRS-2
1 # 10 + 1 # 16 + 1 # 18	SGRP-3	SGRS-3	1 # 14 + 1 # 16 + 1 # 20	SGRP-2	SGRS-2	1 # 16 + 5 # 18	SGRP-3	SGRS-3
1 # 10 + 1 # 16 + 2 # 18	SGRP-3	SGRS-3	1 # 14 + 1 # 16 + 1 # 18	SGRP-3	SGRS-3	1 # 16 + 4 # 18 + 1 # 20	SGRP-3	SGRS-3
1 # 10 + 2 # 16	SGRP-3	SGRS-3	1 # 14 + 1 # 16 + 2 # 18	SGRP-3	SGRS-3	1 # 16 + 4 # 18	SGRP-3	SGRS-3
1 # 10 + 3 # 16	SGRP-4	SGRS-4	1 # 14 + 1 # 16 + 3 # 18	SGRP-3	SGRS-3	1 # 16 + 3 # 18 + 2 # 20	SGRP-3	SGRS-3
1 # 10 + 4 # 16	SGRP-4	SGRS-4	1 # 14 + 1 # 16 + 4 # 18	SGRP-3	SGRS-3	1 # 16 + 3 # 18 + 1 # 20	SGRP-3	SGRS-3
1 # 10 + 5 # 16	SGRP-4	SGRS-4	1 # 14 + 2 # 16	SGRP-3	SGRS-3	1 # 16 + 2 # 18 + 3 # 20	SGRP-3	SGRS-3
1 # 10 + 1 # 14	SGRP-3	SGRS-3	1 # 14 + 2 # 16 + 1 # 18	SGRP-3	SGRS-3	1 # 16 + 2 # 18 + 1 # 20	SGRP-2	SGRS-2
1 # 10 + 1 # 14 + 1 # 18	SGRP-3	SGRS-3	1 # 14 + 2 # 16 + 2 # 18	SGRP-3	SGRS-3	1 # 16 + 2 # 18	SGRP-2	SGRS-2
1 # 10 + 1 # 14 + 1 # 16	SGRP-3	SGRS-3	1 # 14 + 2 # 16 + 3 # 18	SGRP-3	SGRS-3	1 # 16 + 1 # 18 + 4 # 20	SGRP-3	SGRS-3
1 # 10 + 1 # 14 + 2 # 16	SGRP-3	SGRS-3	1 # 14 + 3 # 16	SGRP-3	SGRS-3	1 # 16 + 1 # 18 + 3 # 20	SGRP-2	SGRS-2
1 # 10 + 1 # 14 + 3 # 16	SGRP-4	SGRS-4	1 # 14 + 3 # 16 + 1 # 18	SGRP-3	SGRS-3	1 # 16 + 1 # 18 + 2 # 20	SGRP-2	SGRS-2
1 # 10 + 2 # 14	SGRP-4	SGRS-4	1 # 14 + 3 # 16 + 2 # 18	SGRP-3	SGRS-3	1 # 16 + 1 # 18 + 1 # 20	SGRP-2	SGRS-2
1 # 10 + 3 # 14	SGRP-4	SGRS-4	1 # 14 + 4 # 16	SGRP-3	SGRS-3	1 # 16 + 1 # 18	SGRP-1	SGRS-1
1 # 10 + 1 # 12	SGRP-3	SGRS-3	1 # 14 + 4 # 16 + 1 # 18	SGRP-3	SGRS-3	1 # 16 + 4 # 20	SGRP-2	SGRS-2
1 # 10 + 1 # 12 + 1 # 14	SGRP-4	SGRS-4	1 # 14 + 5 # 16	SGRP-3	SGRS-3	1 # 16 + 3 # 20	SGRP-2	SGRS-2
1 # 10 + 2 # 12	SGRP-4	SGRS-4	2 # 14	SGRP-2	SGRS-2	1 # 16 + 1 # 20 + 1 # 22	SGRP-1	SGRS-1
2 # 10	SGRP-4	SGRS-4	2 # 14 + 1 # 16	SGRP-3	SGRS-3	1 # 16 + 1 # 20	SGRP-1	SGRS-1
2 # 10 + 1 # 16	SGRP-4	SGRS-4	2 # 14 + 1 # 16	SGRP-3	SGRS-3	1 # 16 + 3 # 22	SGRP-1	SGRS-1
1 # 12 + 1 # 18	SGRP-2	SGRS-2	2 # 14 + 1 # 16	SGRP-3	SGRS-3	1 # 16 + 2 # 22	SGRP-1	SGRS-1
1 # 12 + 2 # 18	SGRP-3	SGRS-3	2 # 14 + 1 # 16	SGRP-3	SGRS-3	1 # 16 + 1 # 22	SGRP-1	SGRS-1
1 # 12 + 3 # 18	SGRP-3	SGRS-3	2 # 14 + 2 # 16	SGRP-3	SGRS-3	1 # 18 + 1 # 22	SGRP-1	SGRS-1
1 # 12 + 4 # 18	SGRP-3	SGRS-3	2 # 14 + 2 # 16	SGRP-3	SGRS-3	1 # 18 + 2 # 22	SGRP-1	SGRS-1
1 # 12 + 5 # 18	SGRP-3	SGRS-3	2 # 14 + 3 # 16	SGRP-3	SGRS-3	1 # 18 + 3 # 22	SGRP-1	SGRS-1
1 # 12 + 1 # 16	SGRP-3	SGRS-3	2 # 14 + 4 # 16	SGRP-4	SGRS-4	1 # 18 + 1 # 20	SGRP-1	SGRS-1
1 # 12 + 1 # 16 + 1 # 18	SGRP-3	SGRS-3	3 # 14	SGRP-3	SGRS-3	1 # 18 + 1 # 20 + 1 # 22	SGRP-1	SGRS-1
1 # 12 + 1 # 16 + 2 # 18	SGRP-3	SGRS-3	3 # 14 + 1 # 16	SGRP-3	SGRS-3	1 # 18 + 1 # 20 + 2 # 22	SGRP-1	SGRS-1
1 # 12 + 1 # 16 + 3 # 18	SGRP-3	SGRS-3	3 # 14 + 2 # 16	SGRP-4	SGRS-4	1 # 18 + 2 # 20	SGRP-1	SGRS-1
1 # 12 + 1 # 16 + 4 # 18	SGRP-4	SGRS-4	3 # 14 + 3 # 16	SGRP-4	SGRS-4	1 # 18 + 3 # 20	SGRP-2	SGRS-2
1 # 12 + 2 # 16	SGRP-3	SGRS-3	4 # 14	SGRP-3	SGRS-3	1 # 18 + 4 # 20	SGRP-2	SGRS-2

Table C. SolderGrip Wire Combinations (Continued)

Wire Combinations	Splash-proof	Sealed	Wire Combinations	Splash-proof	Sealed	Wire Combinations	Splash-proof	Sealed
1 # 12 + 2 # 16 + 1 # 18	SGRP-3	SGRS-3	4 # 14 + 1 # 16	SGRP-4	SGRS-4	1 # 18 + 5 # 20	SGRP-2	SGRS-2
1 # 12 + 2 # 16 + 2 # 18	SGRP-3	SGRS-3	4 # 14 + 2 # 16	SGRP-4	SGRS-4	2 # 18	SGRP-1	SGRS-1
1 # 12 + 3 # 16	SGRP-3	SGRS-3	5 # 14	SGRP-4	SGRS-4	2 # 18 + 1 # 22	SGRP-1	SGRS-1
1 # 12 + 4 # 16	SGRP-3	SGRS-3	5 # 14 + 1 # 16	SGRP-4	SGRS-4	2 # 18 + 1 # 20	SGRP-2	SGRS-2
1 # 12 + 5 # 16	SGRP-4	SGRS-4	1 # 16 + 3 # 18	SGRP-3	SGRS-3	2 # 18 + 2 # 20	SGRP-2	SGRS-2
1 # 12 + 1 # 14 + 1 # 18	SGRP-3	SGRS-3	1 # 16 + 2 # 18 + 2 # 20	SGRP-3	SGRS-3	2 # 18 + 3 # 20	SGRP-2	SGRS-2
1 # 12 + 1 # 14 + 2 # 18	SGRP-3	SGRS-3	1 # 16 + 5 # 20	SGRP-3	SGRS-3	2 # 18 + 4 # 20	SGRP-3	SGRS-3
1 # 12 + 1 # 14 + 3 # 18	SGRP-3	SGRS-3	1 # 16 + 2 # 20	SGRP-2	SGRS-2	3 # 18	SGRP-2	SGRS-2
1 # 12 + 1 # 14 + 1 # 16	SGRP-3	SGRS-3	6 # 16	SGRP-3	SGRS-3	3 # 18 + 1 # 20	SGRP-2	SGRS-2
1 # 12 + 1 # 14 + 2 # 16	SGRP-3	SGRS-3	5 # 16 + 1 # 18	SGRP-3	SGRS-3	3 # 18 + 2 # 20	SGRP-3	SGRS-3
1 # 12 + 1 # 14 + 3 # 16	SGRP-4	SGRS-4	5 # 16 + 1 # 20	SGRP-3	SGRS-3	3 # 18 + 3 # 20	SGRP-3	SGRS-3
1 # 12 + 1 # 14 + 4 # 16	SGRP-4	SGRS-4	5 # 16	SGRP-3	SGRS-3	4 # 18	SGRP-2	SGRS-2
1 # 12 + 2 # 14	SGRP-3	SGRS-3	4 # 16 + 2 # 18	SGRP-3	SGRS-3	4 # 18 + 1 # 20	SGRP-3	SGRS-3
1 # 12 + 2 # 14 + 1 # 18	SGRP-3	SGRS-3	4 # 16 + 1 # 18 + 1 # 20	SGRP-3	SGRS-3	4 # 18 + 2 # 20	SGRP-3	SGRS-3
1 # 12 + 2 # 14 + 1 # 16	SGRP-4	SGRS-4	4 # 16 + 1 # 18	SGRP-3	SGRS-3	5 # 18	SGRP-3	SGRS-3
1 # 12 + 2 # 14 + 2 # 16	SGRP-4	SGRS-4	4 # 16 + 2 # 20	SGRP-3	SGRS-3	5 # 18 + 1 # 20	SGRP-3	SGRS-3
1 # 12 + 2 # 14 + 3 # 16	SGRP-4	SGRS-4	4 # 16 + 1 # 20	SGRP-3	SGRS-3	6 # 18	SGRP-3	SGRS-3
1 # 12 + 3 # 14	SGRP-4	SGRS-4	4 # 16	SGRP-3	SGRS-3	1 # 20 + 1 # 22	SGRP-1	SGRS-1
1 # 12 + 3 # 14 + 1 # 16	SGRP-4	SGRS-4	3 # 16 + 3 # 18	SGRP-3	SGRS-3	1 # 20 + 2 # 22	SGRP-1	SGRS-1
1 # 12 + 4 # 14	SGRP-4	SGRS-4	3 # 16 + 2 # 18 + 1 # 20	SGRP-3	SGRS-3	1 # 20 + 3 # 22	SGRP-1	SGRS-1
2 # 12	SGRP-4	SGRS-4	3 # 16 + 2 # 18	SGRP-3	SGRS-3	1 # 20 + 4 # 22	SGRP-1	SGRS-1
2 # 12 + 1 # 18	SGRP-3	SGRS-3	3 # 16 + 1 # 18 + 2 # 20	SGRP-3	SGRS-3	2 # 20	SGRP-1	SGRS-1
2 # 12 + 1 # 18	SGRP-3	SGRS-3	3 # 16 + 1 # 18 + 1 # 20	SGRP-3	SGRS-3	2 # 20 + 1 # 22	SGRP-1	SGRS-1
2 # 12 + 1 # 16	SGRP-3	SGRS-3	3 # 16 + 1 # 18	SGRP-3	SGRS-3	2 # 20 + 2 # 22	SGRP-1	SGRS-1
2 # 12 + 2 # 16 + 1 # 18	SGRP-4	SGRS-4	3 # 16 + 3 # 20	SGRP-3	SGRS-3	2 # 20 + 3 # 22	SGRP-1	SGRS-1
2 # 12 + 3 # 16	SGRP-4	SGRS-4	3 # 16 + 2 # 20	SGRP-3	SGRS-3	3 # 20	SGRP-1	SGRS-1
2 # 12 + 1 # 14 + 1 # 18	SGRP-4	SGRS-4	3 # 16 + 1 # 20	SGRP-3	SGRS-3	3 # 20 + 1 # 22	SGRP-1	SGRS-1
2 # 12 + 1 # 14 + 1 # 16	SGRP-4	SGRS-4	3 # 16	SGRP-2	SGRS-2	4 # 20	SGRP-2	SGRS-2
3 # 12 + 1 # 14	SGRP-4	SGRS-4	2 # 16 + 4 # 18	SGRP-3	SGRS-3	5 # 20	SGRP-2	SGRS-2
3 # 12 + 2 # 14	SGRP-4	SGRS-4	2 # 16 + 3 # 18 + 1 # 20	SGRP-3	SGRS-3	6 # 20	SGRP-2	SGRS-2
3 # 12 + 1 # 18	SGRP-4	SGRS-4	2 # 16 + 3 # 18	SGRP-3	SGRS-3	3 # 22	SGRP-1	SGRS-1
3 # 12 + 1 # 16	SGRP-4	SGRS-4	2 # 16 + 2 # 18 + 2 # 20	SGRP-3	SGRS-3	4 # 22	SGRP-1	SGRS-1
1 # 14 + 1 # 22	SGRP-1	SGRS-1	2 # 16 + 2 # 18 + 1 # 20	SGRP-3	SGRS-3	5 # 22	SGRP-1	SGRS-1
1 # 14 + 1 # 20	SGRP-2	SGRS-2	2 # 16 + 2 # 18	SGRP-3	SGRS-3	6 # 22	SGRP-1	SGRS-1
1 # 14 + 2 # 20	SGRP-2	SGRS-2	—	—	—	—	—	—

Product Characteristics

Material			
Insulation	Radiation-crosslinked, transparent heat-shrinkable polyvinylidene fluoride		
Solder preform with flux	Sn 60, Pb 40, ROM 1 flux per ANSI-J-STD-004 (RA flux).		
Sealing insert (SGRS)	Hot melt adhesive		
Spiral wound insert	Copper alloy		
Physical	Unit	Method of test	Requirement
Dimensions	inches	RB-109	See product dimensions.
Electromechanical	Unit	Method of test	Typical values
Dielectric withstand voltage	kilovolts	RB-109	2.0
Static heating	degrees	RB-109	Less than 50°C rise
Environmental*	Unit	Method of test	Requirement
Insulation resistance after water immersion (SGRS only)	megohms	RB-109	100
Contact resistance after exposure	milliohms	RB-109	Less than 6 milliohms
Operating condition	Unit	Method of test	Value
Temperature rating	—	—	-55°C to 125°C [-67°F to 257°F]
Voltage rating	volts	—	600

*Immersion resistance sealing is dependent on the wire combinations used. The user should test specific wire combinations. Refer to RB-109 Raychem specification for procedures.

Approvals and Reference Documents

Agency Approvals	UL, CUL E87681
Reference documents	Raychem Specification RB-109 for splices SolderGrip Terminators Selection Guide (H54640), SolderGrip Terminators Installation Procedure (H54636) Specification Control Drawings Splices—Non Sealed (SGRP-X), Splices—Sealed (SGRS-X)

Installation

The SolderGrip product is pushed onto the conductors with a twisting motion. With the product in place, installation can be completed with the proper selection and use of heating tools and reflectors. Either of the following Raychem heating tools is recommended:

- HL1802E
- CV-1981

Refer to Raychem installation procedure RPIP 820-00 for detailed instructions and recommended reflector attachments.

You will find ordering information for these tools on pages 9102-9109.

DuraSeal Heat-Shrinkable, Environmentally Sealed, Nylon-Insulated Crimp Splices

Product Facts

- Protects splices from water, condensation, salt, and corrosion
- Provides strain relief
- Protects against vibration in rugged environments
- Completely insulates and protects electrical connections
- Has adhesive lining for protection that is more reliable than conventional splices
- UL, CUL, and Lloyd's listed 



Applications

- Automotive/truck wiring repair and maintenance.
- Automotive accessory installations.
- OEM automotive/truck/RV wire harness fabrication.
- Marine electronics.
- Fleet maintenance.
- Commercial wiring (pumps/pools/spas).

Specifications/Approvals

Series	Agency	Raychem
D-406	UL and CUL listed 91J4, File E87681	RB-107
—	Lloyd's listed, File 65 247 HH 02-93	—

Product Dimensions

Butt Splices

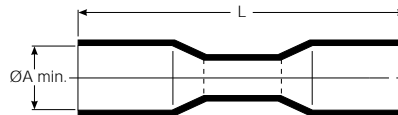

Part No.	Butt Splice Dimensions		Color	Conductor	Wire Dimensions	
	A Min.	L Nom.			Insulation O.D. (Max.)	Insulation O.D. (Min.)
D-406-0001	3.68 [.145]	3.75 [1.25]	Red	22-18	3.56 [.140]	1.40 [.055]
D-406-0002	4.57 [.180]	3.75 [1.25]	Blue	16-14	4.45 [.175]	2.03 [.080]
D-406-0003	6.35 [.250]	38.10 [1.50]	Yellow	12-10	6.22 [.245]	—

**DuraSeal Heat-Shrinkable, Environmentally Sealed,
Nylon-Insulated Crimp Splices (Continued)**

Product Selection Process

1. Determine wire size.
2. Select part number.

Wire Size AWG	mm ²	Part No.	Color
22-18	0.38-0.95	D-406-0001	Red
16-14	1.2-2.5	D-406-0002	Blue
12-10	3-6	D-406-0003	Yellow

**Product Characteristics
(Typical)**

Operating temperature	-55°C to 125°C [-67°F to 257°F]
Shrink ratio	Approximately 2:1
Physical properties	Cut-through resistance: 31 kg [70 lb] Wire pullout after crimping and recovery: red: 11.3 kg [25 lb]; blue: 22.7 kg [50 lb]; yellow: 27.2 kg [60 lb] Not flame-retardant No cracking after heat aging for 168 h at 160°C [320°F]
Chemical properties	Solvent resistance: isopropyl alcohol, trichloroethylene, gasoline, battery acid, diesel fuel, motor oil, antifreeze, brake fluid, 5% salt water
Electrical properties	Dielectric strength: 2500 Vac Insulation resistance: 1000 megohms at 100 Vdc

Installation Requirements

For proper installation of these devices, the correct crimp tool and a heating tool with a reflector attachment must be used. The Raychem AD-1522 crimp tool and HL1802E heating tool are recommended.

You will find ordering information for these tools on pages 9102-9109.

Refer to Raychem installation procedure RPIP 821-00 for detailed instructions.

Installation

1. Select splice of appropriate size. Strip wire 7.5 mm (5/16 in). Insert into crimp barrel.

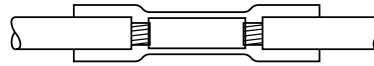

2. Crimp using Raychem AD-1522 crimp tool for preinsulated crimps.

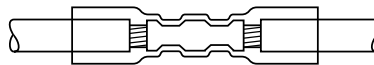

3. Heat crimped splice with heat gun until tubing recovers and adhesive flows.

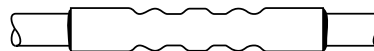

MiniSeal High-Performance, Immersion-Resistant Crimp Splices

Product Facts

- Immersion-resistant crimp splices are on QPL for MIL-S-81824
- MIL-Spec approval
- Small size
- Light weight
- Insulation and strain relief
- Easy installation

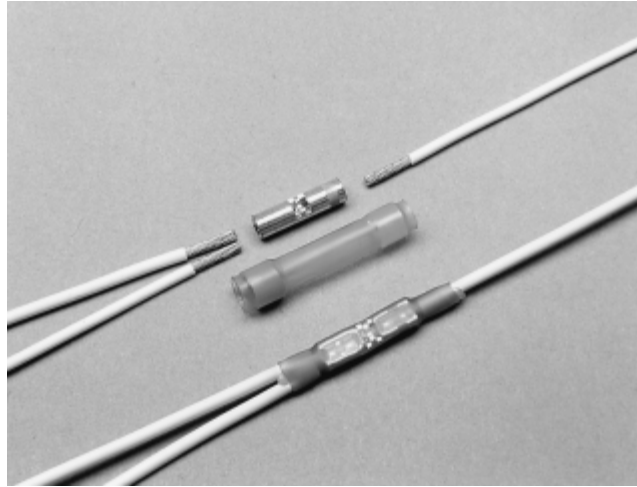

Applications

MiniSeal wire-to-wire splicing products offer solutions for hundreds of aerospace and defense applications. These environment-resistant splices provide excellent reliability, long term performance, MIL-S-81824/1 qualification, and a low installed cost.

MiniSeal crimp splices consist of a plated copper crimp barrel and a separate, heat-shrinkable, transparent sealing sleeve. They can be used on a combination of wires, from 1:1 to 10:10. MiniSeal splices are one of the smallest, lightest, and most environment-resistant splices available. They preserve the electrical integrity of the splice by preventing the penetration of liquids and the resulting chemical and galvanic corrosion.

Product Selection Process

1. Determine the type of splice required.

- Stub (parallel) splice:



- Butt (in-line) splice:

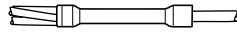

2. Determine which crimp barrel plating is required:

- Tin plating, recommended for tin or silverplated wire

- Nickel plating, recommended for nickel-plated wire, or silver-plated wire in applications above 150°C [302°F].

3. Calculate the size of crimp barrel required.

Using the CMA/mm² worksheet on the next page, calculate the total cross section to be spliced by adding the circular mil area (CMA) or square millimeters (mm²) of each wire.

Stub splice: Add the CMA or mm² of all wires together.

Butt splice: Calculate each side separately (see example on the worksheet).

Table A provides the CMA of typical conductors. (Both CMA and mm² give the same results, so choose either CMA or mm² as your unit of measure for selection purposes and continue to use it for all your selection criteria.)

4. Select the color code for the size crimp barrel required. Using Table B (page 9064), select the crimp barrel—color-coded red, blue, or yellow—for the CMA or mm² you calculated.

Stub splice: Select the barrel that will accommodate the total cross section.

Butt splice: Select the smallest barrel that will accommodate the largest CMA/mm² required. (Refer to the example in the worksheet for a more specific description.) If the CMA/mm² of the smaller side of a butt splice is too small for the size barrel required to fit the larger side, increase the CMA/mm²—either by doubling back one wire (stripping the conductor twice the length you would ordinarily strip it and then folding it back) or by adding a filler wire.

5. Determine the type of sealing sleeve required. Some wire insulations will not fit in the holes of the sealing sleeve inserts, so be sure to compare the internal diameter of each hole with the outer diameter of the wire(s) you intend to insert in that hole. To create a reliable seal, place a maximum of two wires in any hole of the sealing sleeve.
6. Select the part number. Turn to the MiniSeal part number selection tables (Tables C and D, page 9066) and find the table for the type of splice (stub or butt) required.

Using the appropriate table, find the crimp barrel size range and the size and number of wires for your application. Then select the part number for the type of plating required. The color code accompanying that part number should match the color code you arrived at in Table B, confirming that the part number you have selected is correct.

Table A. CMA of Typical Conductors

MiniSeal High-Performance, Immersion-Resistant Crimp Splices (Continued)

Strands	7	19	19	19	19	19	19	19	37
AWG	28	26	24	22	20	18	16	14	12
CMA	177	304	475	754	1216	1900	2426	3831	5874
mm ²	0.09	0.15	0.24	0.38	0.61	0.95	1.21	1.92	2.94

Table B. Crimp Barrel Color Code Selection

CMA Range	mm ² Range	1:1 Splice (AWG Size)	Color Code
304–1510	0.15–0.75	26–20	Red
779–2680	0.39–1.34	20–16	Blue
1900–6755	0.95–3.37	18–12	Yellow

CMA/mm² Worksheet

Example:

Application: A butt splice with three AWG 22 wires in one side and one AWG 18 wire in the other side:

The CMA for AWG 22 wire in Table A is 754 (0.38 mm²).

Side one is therefore calculated as follows:

$$CMA = 3 \times 754 = 2262$$

$$(mm^2 = 3 \times 0.38 = 1.14)$$

The other side, where the CMA for AWG 18 is 1900, is calculated as:

$$CMA = 1 \times 1900 = 1900$$

$$(mm^2 = 1 \times 0.95 = 0.95)$$

Using Table B to select the smallest crimp barrel that will easily fit 2262 CMA (0.95 mm²), the blue barrel is the correct choice.

Wire Number	CMA	mm ²	
1	_____	_____	
2	_____	_____	
3	_____	_____	
4	_____	_____	
5	_____	_____	
6	_____	_____	
7	_____	_____	
8	_____	_____	
9	_____	_____	
10	_____	_____	
Total	_____	_____	Part Number: _____

Table C. Stub (Parallel) Splices

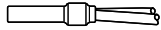

Illustration	Part No.		Crimp Barrel Size Range CMA [mm ²] Min.–Max.	I.D.dimensions			
	Tin Plated	Nickel Plated		Side 1		Side 2	
				Sealing Insert	Max. No. of Wires	Sealing Insert	Max. No. of Wires
	D-436-0128 Red	D-436-0119 Red	304–1510 [0.15–0.75]	 2.16 [.085]	2	 1.01 [.040]	2
	D-436-58 Blue	D-436-75 Blue	779–2680 [0.39–1.34]	 4.56 [.180]	2	 2.28 [.090]	2
	D-436-59 Yellow	D-436-76 Yellow	1900–6755 [0.95–3.37]	 4.56 [.180]	2	 2.28 [.090]	2
	D-436-60 Blue	D-436-77 Blue	779–2680 [0.39–1.34]	 2.03 [.080]	10 (2 per hole)	 6.35 [.250]	2
	D-436-61 Yellow	D-436-78 Yellow	1900–6755 [0.95–3.37]	 2.03 [.080]	10 (2 per hole)	 6.35 [.250]	2

Table D. Butt (in-line) splices

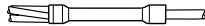

Illustration	Part No.		Crimp Barrel Size Range CMA [mm ²] Min.–Max.	I.D.dimensions			
	Tin Plated	Nickel Plated		Side 1		Side 2	
				Sealing Insert	Max. No. of Wires	Sealing Insert	Max. No. of Wires
	D-436-36* Red	D-436-82 Red	304–1510 [0.15–0.75]	 2.16 [.085]	2	 2.16 [.085]	2
	D-436-37* Blue	D-436-83 Blue	779–2680 [0.39–1.34]	 2.79 [.110]	2	 2.79 [.110]	2
	D-436-38* Yellow	D-436-84 Yellow	1900–6755 [0.95–3.37]	 4.32 [.170]	2	 4.32 [.170]	2
	D-436-0110 Red	D-436-85 Red	304–1510 [0.15–0.75]	 2.36 [.093]	6	 4.06 [.160]	2
	D-436-52 Blue	D-436-86 Blue	779–2680 [0.39–1.34]	 2.36 [.093]	6 (2 per hole)	 4.06 [.160]	2
	D-436-53 Yellow	D-436-87 Yellow	1900–6755 [0.95–3.37]	 2.36 [.093]	6 (2 per hole)	 4.06 [.160]	2
	D-436-0115 Red	D-436-88 Red	304–1510 [0.15–0.75]	 2.36 [.093]	6 (2 per hole)	 2.36 [.093]	6 (2 per hole)
	D-436-42 Blue	D-436-89 Blue	779–2680 [0.39–1.34]	 2.36 [.093]	6 (2 per hole)	 2.36 [.093]	6 (2 per hole)
	D-436-43 Yellow	D-436-90 Yellow	1900–6755 [0.95–3.37]	 2.36 [.093]	6 (2 per hole)	 2.36 [.093]	6

*Qualified to MIL-S-81824/1.

Product Characteristics

MiniSeal High-Performance, Immersion-Resistant Crimp Splices (Continued)

Material	
Insulation	Radiation-crosslinked, heat-shrinkable polyvinylidene fluoride
Crimp barrel	Tin- or nickel-plated copper (see Table C)
Melttable inserts	Melttable thermoplastic
Typical Performance	
Voltage drop	6.9 mV at 4.5 A vs 8.1 mV for an equal length of wire
Tensile strength	Exceeds strength of conductor
Dielectric strength	2.5 kV
Temperature rating	-55°C to 150°C [-67°F to 302°F]
Insulation resistance	5000 megohms

Specifications/Approvals

Series	Military
D-436	MIL-S-81824/1 for D-436-36/37/38

Installation

For proper installation of these devices, the correct crimp tool (Raychem part number AD-1377) and a heating tool and reflector attachment must be used.

Any one of the following Raychem heating tools is recommended:

- HL1802E
- AA-400 Super Heater

Refer to Raychem installation procedure RCPS 200-20 for detailed instructions and recommended reflector attachments.

You will find ordering information for these tools on pages 9102-9109.

Introduction

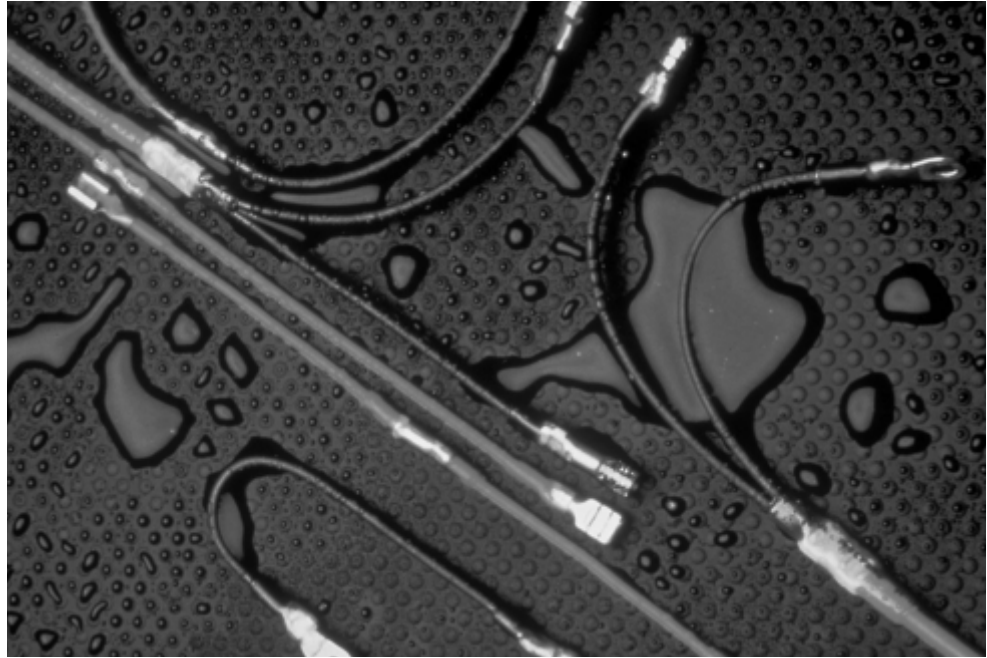

Raychem insulated electrical terminal products provide reliable, repeatable, and rugged examples of terminals available. We start on the front end with terminal sizes and configurations that meet or exceed industry standards in terms of material selection, surface treatment, and electrical performance.

Here the comparison stops. What separates Raychem products from the rest of the industry are the materials and termination techniques used on the back end of the products, which provide unparalleled value.

Products include:

- *DuraSeal heat-shrinkable nylon crimp products*, which protect against water, condensation, salt, and corrosion. Their tough, heat-shrinkable nylon tubing resists abrasion and cut-through

damage, provides strain relief, and protects against vibration damage. DuraSeal products are simple and quick to install using a crimp tool and a heat source. They accommodate a wide range of wire sizes and are color-coded for easy identification, yet are transparent for visual inspection of the finished splice.

- *SolderGrip heat-shrinkable twist-on products*, which utilize a spiral copper coil that grips and compresses the conductors and allows a prefluxed solder ring to flow to the center of the splicing area, resulting in a highly reliable, repeatable joint. SolderGrip terminals use a durable polyvinylidene fluoride heat-shrinkable tubing that protects the electrical joint and provides insulation and strain relief. The

SolderGrip technology is a reliable means of terminating more than two conductors time after time. SolderGrip terminals can terminate a variety of conductor types (solid and stranded) and platings. Terminations on more than eight individual conductors in a single joint have been successfully demonstrated using this product.

DuraSeal product delivers protected electrical joints on industry standard terminals and is suitable for harsh environments.

Product Facts

- Resistance to moisture and abrasion
- Strain relief
- Protection from wire pull-out
- Easy installation
- UL and CUL listed 

Approvals and Reference Documents

Insulated Terminals and Disconnects

DuraSeal Heat-Shrinkable Environmentally Sealed, Nylon Insulated Crimp Terminals and Disconnects

Applications

DuraSeal products insulate and protect electrical connections from mechanical abuse, wire pull-out, and abrasion while resisting water, salt, and other contaminants.

DuraSeal devices provide a tough, environmentally sealed wire connection. Their crimp barrel or terminal, encased in rugged, heat-shrinkable nylon tubing lined with a special hot-melt adhesive, resists damage from abrasions and cuts.

DuraSeal devices retain flexibility and impact-resistance long after similar products have become brittle.

DuraSeal devices accommodate wire gauge sizes 22 to 10. They are color-coded for easy identification of gauge sizes, yet transparent for inspection of the finished splice.

Agency approvals	UL listed component, file E87681, terminals except quick connect terminals; file E157833, quick connect terminals
Reference documents	Raychem specifications RB-108, Specification DuraSeal crimp terminals DuraSeal selection guide (H54153) DuraSeal installation guidelines (H54154)

DuraSeal Heat-Shrinkable Environmentally Sealed, Nylon Insulated Crimp Terminals and Disconnects (Continued)

Product Characteristics

	Property	Unit	Requirement	Method of Test
Physical	Dimensions	Inches	None	See product dimensions UL486C, IEC512-8
	Tensile strength	Pounds	8 to 40 lbs depending on AWG	
Electrical	Property	Unit	Typical value	Method of Test
	Voltage drop	Millivolts	Less than equal length of wire	MIL-S-81824, IEC512-2
	Insulation resistance	Megohms	103 min.	MIL-STD-202 method 302
	Dielectric withstand voltage	Kilovolts	2.5	MIL-STD-202F method 301, IEC512-2
Chemical	Property	Unit	Requirement	Method of Test
	Diesel fuel Brake fluid Antifreeze 5% salt water Motor oil	—	Meet electrical test listed above after conditioning.	ASTM D 3032, ESA-603D
Environmental (Fluid)	Humidity	—	Meet electrical test listed above after conditioning.	MIL-STD-202F method 106, IEC68-2-30
	Immersion	—		MIL-STD-202F condition C, IEC68-2-14 test NC
	Vibration	—		MIL-STD-202F method 201, IEC68-2-6
	Bending	—		UL486C, IEC512-8
	Thermal shock	—		MIL-STD-202F method 107, IEC68-2-14 test N
Operating conditions	Heat aging (168° @ 85°C [185°F])	—	MIL-STD-202F, IEC68-2-2	MIL-STD-202F method 101, IEC68-2-11
	Temperature rating	—	-55°C to +125°C [-67°F to -257°F]	None
	Minimum shrink temperature	—	180°C [356°F]	None
	Voltage rating	—	600 Volt max	None

Fork Terminals

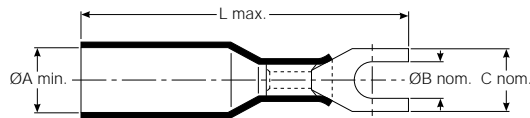

Part No.	Fork Terminal Dimensions				Color	Insulation Conductor (AWG)	Wire Dimensions	
	A Min.	Stud Size	C Nom.	L Max.			Insulation O.D. (Max.)	O.D. (Min.)
B-106-2401	3.81 [.15]	8	7.88 [.31]	32.00 [1.26]	Red	22-18	3.81 [.150]	1.40 [.055]
B-106-2402	4.57 [.18]	8	1 [.31]	35.05 [1.38]	Blue	16-14	4.45 [.175]	2.00 [.080]
B-106-2403	6.35 [.25]	8	1 [.31]	38.10 [1.50]	Yellow	12-10	6.35 [.250]	2.79 [.110]
B-106-2502	4.57 [.18]	10	9.91 [.39]	35.05 [1.38]	Blue	16-14	4.45 [.175]	2.00 [.080]
B-106-2503	6.35 [.25]	10	9.91 [.39]	40.15 [1.58]	Yellow	12-10	6.35 [.250]	2.79 [.110]

DuraSeal Heat-Shrinkable Environmentally Sealed, Nylon Insulated Crimp Terminals and Disconnects (Continued)

Ring Terminals

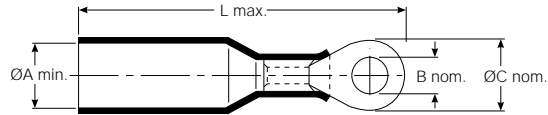

Part No.	Fork Terminal Dimensions				Color	Insulation Conductor (AWG)	Wire Dimensions	
	A Min.	Stud Size	C Nom.	L Max.			Insulation O.D. (Max.)	O.D. (Min.)
B-106-1401	3.81 [.15]	8	7.88 [.31]	32.00 [1.26]	Red	22-18	3.81 [.150]	1.40 [.055]
B-106-1501	3.81 [.15]	10	9.91 [.39]	34.04 [1.34]	Red	22-18	3.81 [.150]	1.40 [.055]
B-106-1601	3.81 [.15]	1/4	11.94 [.47]	36.07 [1.42]	Red	22-18	3.81 [.150]	1.40 [.055]
B-106-1801	3.81 [.15]	5/16	13.97 [.55]	39.12 [1.54]	Red	22-18	3.81 [.150]	1.40 [.055]
B-106-1991	3.81 [.15]	3/8	17.78 [.70]	43.18 [1.70]	Red	22-18	3.81 [.150]	1.40 [.055]
B-106-1402	4.57 [.18]	8	7.88 [.31]	33.02 [1.30]	Blue	16-14	4.45 [.175]	2.00 [.080]
B-106-1502	4.57 [.18]	10	9.91 [.39]	35.05 [1.38]	Blue	16-14	4.45 [.175]	2.00 [.080]
B-106-1602	4.57 [.18]	1/4	11.94 [.47]	36.58 [1.44]	Blue	16-14	4.45 [.175]	2.00 [.080]
B-106-1802	4.57 [.18]	5/16	13.97 [.55]	40.13 [1.58]	Blue	16-14	4.45 [.175]	2.00 [.080]
B-106-1992	4.57 [.18]	3/8	17.78 [.70]	43.94 [1.73]	Blue	16-14	4.45 [.175]	2.00 [.080]
B-106-1403	6.35 [.25]	8	7.88 [.31]	38.10 [1.50]	Yellow	12-10	6.35 [.250]	2.79 [.110]
B-106-1503	6.35 [.25]	10	9.91 [.39]	40.13 [1.58]	Yellow	12-10	6.35 [.250]	2.79 [.110]
B-106-1603	6.35 [.25]	1/4	11.94 [.47]	41.66 [1.64]	Yellow	12-10	6.35 [.250]	2.79 [.110]
B-106-1803	6.35 [.25]	5/16	13.97 [.55]	45.21 [1.78]	Yellow	12-10	6.35 [.250]	2.79 [.110]
B-106-1993	6.35 [.25]	3/8	17.78 [.70]	46.99 [1.85]	Yellow	12-10	6.35 [.250]	2.79 [.110]

DuraSeal Heat-Shrinkable Environmentally Sealed, Nylon Insulated Crimp Terminals and Disconnects (Continued)

Push-on Terminals

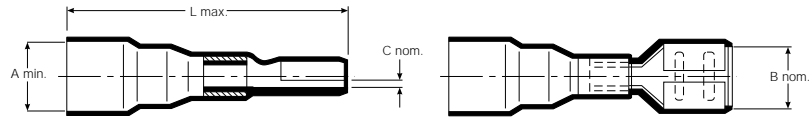

Part No.	Tab Size	Push-on Terminal Dimensions				Color	Insulation Conductor (AWG)	Wire Dimensions	
		A Min.	B Nom.	C Nom.	L Max.			Insulation O.D. (Max.)	O.D. (Min.)
B-106-3631	.250 x .032	3.81 [.150]	6.35 [.250]	.81 [.032]	30.48 [1.200]	Red	22-18	3.81 [.150]	1.40 [.055]
B-106-3632	.250 x .032	4.57 [.180]	6.35 [.250]	.81 [.032]	32.00 [1.260]	Blue	16-14	4.45 [.175]	2.00 [.080]
B-106-3633	.250 x .032	6.35 [.250]	6.35 [.250]	.81 [.032]	33.02 [1.300]	Yellow	12-10	6.35 [.250]	2.79 [.110]
B-106-3281	.110 x .020	3.81 [.150]	2.79 [.110]	.51 [.020]	22.86 [.900]	Red	22-18	3.81 [.150]	1.40 [.055]
B-106-3481	.187 x .020	3.81 [.150]	4.75 [.187]	.51 [.020]	30.48 [1.200]	Red	22-18	3.81 [.150]	1.40 [.055]

Tab Terminals

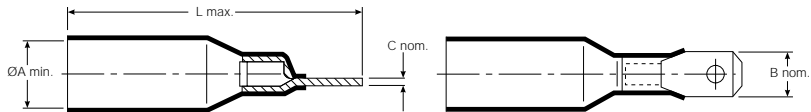

Part No.	Tab Size	Tab Terminal Dimensions				Color	Insulation Conductor (AWG)	Wire Dimensions	
		A Min.	B Nom.	C Nom.	L Max.			Insulation O.D. (Max.)	O.D. (Min.)
B-106-4631	.250 x .032	3.81 [.150]	6.35 [.250]	.81 [.032]	30.48 [1.20]	Red	22-18	3.81 [.150]	1.40 [.055]
B-106-4632	.250 x .032	4.57 [.180]	6.35 [.250]	.81 [.032]	32.00 [1.26]	Blue	16-14	4.45 [.175]	2.00 [.080]

DuraSeal Heat-Shrinkable Environmentally Sealed, Nylon Insulated Crimp Terminals and Disconnects (Continued)

Pin Terminals

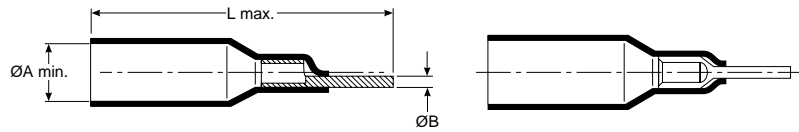

Part No.	Pin Terminal Dimensions			Color	Conductor (AWG)	Wire Dimensions	
	A Min.	B Nom.	L Max.			Insulation O.D. (Max.)	Insulation O.D. (Min.)
B-106-6201	3.81 [.150]	2.00 [.080]	30.99 [1.220]	Red	22-18	3.81 [.150]	1.40 [.055]

Bullet Terminals

Fig. 1

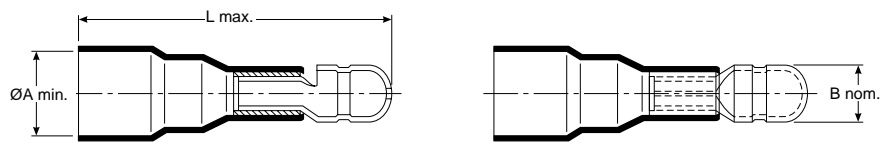
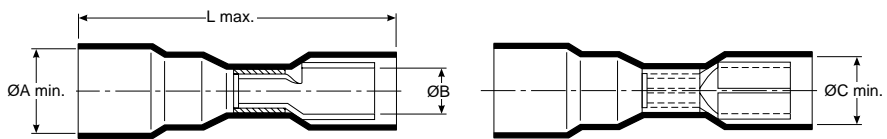

Fig. 2



Part No.	Fig.	Type	Bullet Terminal Dimensions				Color	Conductor (AWG)	Wire Dimensions	
			A Min.	B Nom.	C Min.	L Max.			Insulation O.D. (Max.)	Insulation O.D. (Min.)
B-106-7401	1	M	3.81 [.150]	3.81 [.150]	—	33.53 [1.32]	Red	22-18	3.81 [.150]	1.40 [.055]
B-106-7502	1	M	4.57 [.180]	5.08 [.200]	—	34.54 [1.36]	Blue	16-14	4.45 [.175]	2.00 [.080]
B-106-8401	2	F	3.81 [.150]	3.81 [.150]	5.59 [.220]	30.48 [1.20]	Red	22-18	3.81 [.150]	1.40 [.055]
B-106-8502	2	F	4.57 [.180]	5.08 [.200]	6.10 [.240]	32.51 [1.28]	Blue	16-14	4.45 [.175]	2.00 [.080]

DuraSeal Heat-Shrinkable Environmentally Sealed, Nylon Insulated Crimp Terminals and Disconnects (Continued)

Product Characteristics (Typical)

Operating temperature	-55°C to 125°C [-67°F to 257°F]
Shrink ratio	Approximately 2:1
Physical properties	Cut-through resistance: 31.7 kg [70 lb] Wire pullout after crimping and recovery: red: 11.3 kg [25 lb]; blue: 22.7 kg [50 lb]; yellow: 27.2 kg [60 lb] Not flame-retardant No cracking after heat aging for 168 hr at 160°C [320°F]
Chemical properties	Solvent resistance: isopropyl alcohol, trichloroethylene, gasoline, battery acid, diesel fuel, motor oil, antifreeze, brake fluid, 5% salt water
Electrical properties	Dielectric strength: 1000 V Insulation resistance: 10 megohms

Specifications/Approvals

Series	Agency	Raychem
B-106	UL and CUL 91J4, File E87681 Lloyd's listed, File 65 247 HH 02-93 UL and CUL E157833 (B-106-3XXX/B-106-4XXX)	RB-108

Installation

1. Select appropriate size. For terminal and disconnect terminations, strip wire 6.5 mm (1/4 inch).

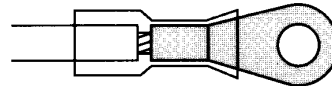

2. Crimp using Raychem AD-1522 crimp tool for preinsulated crimps.

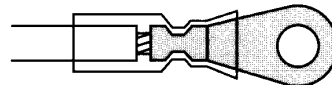

3. Heat terminal or disconnect with heat gun until tubing recovers and adhesive flows. Avoid heating ring or fork metallic parts.

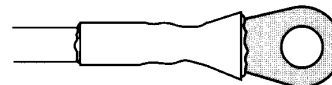

For proper installation of these devices, the correct crimp tool and heating tool with reflector attachment must be used. The Raychem AD-1522 crimp tool and HL1802E heating tool are recommended. You will find ordering information for these tools on pages 9102-9109. Refer to Raychem installation procedure RPIP 684-00 for detailed instructions.

SolderGrip Self-Fixturing Insulated Terminals

Product Facts

- Transparent insulation sleeve provides encapsulation, inspectability, strain relief, and insulation
- Spiral copper coil grips and compresses the conductors for optimum solder connection
- Prefluxed solder preform provides a controlled soldering process.
- One-piece design for easy installation
- Accommodates a wide variety of conductor types, quantities, sizes, and plating types unmatched by any other termination technique
- UL and CUL recognized 
- Parts meet the performance requirements of MIL-T-7928G

Applications

Used for terminating multiple wires to terminals.



Product option

Product Series	Environmental Protection
SGRT	Splashproof

Product Selection Process

1. Determine the wire combination (number of wires and size) of the wire bundle you wish to terminate.
2. Use Table C to select the correct terminal for AWG wire combination.*
Example: For connecting a bundle with one 12 AWG wire (1 #12) and two 18 AWG wires (+ 2 #18) to a terminal, you need an SGRT-4-XX terminal.
3. Determine the correct stud size.
4. Select the correct part number from Table A for that stud size in the terminal series and size you selected in Step 2.
Example: If the stud size is 1/4, select part number SGRT-4-06.
5. Verify that the wire bundle (with wire insulation) does not exceed the maximum diameter allowed for the part you selected. Simply check the bundle's diameter against the maximum diameter that Table A lists for that part.
6. Verify that the total amperage to be applied does not exceed the maximum amp rating for the part as specified in Table A.

*If the wire combination is not listed in Table B, use the CMA (mm²) method of determining wire bundle size (see "CMA/mm² Calculation" on page 9076).
Using Table B, select the smallest size part that will fit your total wire CMA (mm²) value.

Table A. Part Number Selection

SolderGrip Part No.	Stud Size	Maximum Bundle Diameter†	Maximum Amp Rating	Wire Range (Min.-Max.) CMA [mm ²]	Typical Length
SGRT-1-02	2 [2]	4.1 [.161]	12.5 A	1400-5000 [0.7-2.5]	38 [1 1/2]
SGRT-2-03	3 [6]	5.0 [.195]	15 A	2400-6000 [1.2-3.0]	38 [1 1/2]
SGRT-2-04	4 [8]	—	15 A	2400-6000 [1.2-3.0]	38 [1 1/2]
SGRT-2-05	5 [10]	—	15 A	2400-6000 [1.2-3.0]	38 [1 1/2]
SGRT-2-06	6 [1/4]	—	15 A	2400-6000 [1.2-3.0]	38 [1 1/2]
SGRT-3-06	6 [1/4]	6.5 [.255]	33 A	5000-13,200 [2.5-6.6]	44.5 [1 3/4]
SGRT-3-08	8 [5/16]	—	33 A	5000-13,200 [2.5-6.6]	51.0 [2]
SGRT-4-06	6 [1/4]	9.0 [.355]	56 A	12,000-22,400 [6.0-11.2]	44.5 [1 3/4]
SGRT-4-08	8 [5/16]	—	56 A	12,000-22,400 [6.0-11.2]	51 [2]

†Maximum bundle diameter is measured over wire insulation.

CMA/mm² Calculation

SolderGrip Self-Fixturing Insulated Terminals (Continued)

To calculate the total circular mil or mm² area of the wire bundle to be terminated, follow these steps:

1. Choose either CMA or mm² as your unit of measure for selection purposes and continue to use it for all your selection criteria. (Both measures provide the same results.)
2. In the workspace below, list the CMA or mm² for each conductor in the bundle. (Table B provides the CMA of typical conductors.)
3. Add together the values listed in the workspace below to obtain the total area.
4. Use Table A to select the smallest terminator that will fit the total CMA (mm²).

Wire Number	CMA	mm ²	
1	_____	_____	
2	_____	_____	
3	_____	_____	
4	_____	_____	
5	_____	_____	
6	_____	_____	
7	_____	_____	
8	_____	_____	
9	_____	_____	
10	_____	_____	
	_____	_____	Solder GripPart No.
Total			

CMA/mm² Example

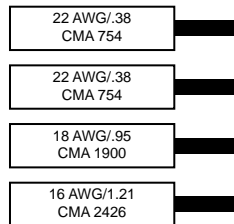

Total CMA = 5834
 Total mm² = 2.92
 Correct part number (based on CMA of 5834 or mm² of 2.92):
 SGRT-2-XX if bundle OD is less than 5.0 mm (0.195 in).

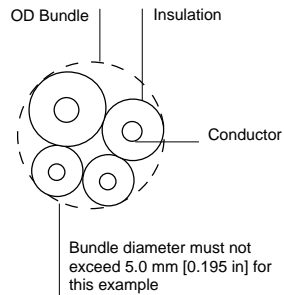

Table B. CMA of Typical Copper Conductors

Strands	7	19	19	19	19	19	19	19	37
AWG	28	26	24	22	20	18	16	14	12
CMA	177	304	475	754	1216	1900	2426	3831	5874
mm ²	0.09	0.15	0.24	0.38	0.61	0.95	1.21	1.92	2.94

Table C. SolderGrip Wire Combinations (see Table A for Terminal Size [-XX])

Wire Combinations	Part No.	Wire Combinations	Part No.	Wire Combinations	Part No.
1 # 8	SGRT-4-XX	1 # 12 + 1 # 16 + 4 # 18	SGRT-4-XX	1 # 14 + 4 # 20	SGRT-3-XX
1 # 8 + 1 # 16	SGRT-4-XX	1 # 12 + 2 # 16	SGRT-3-XX	1 # 14 + 1 # 18	SGRT-2-XX
2 # 8 + 2 # 16	SGRT-4-XX	1 # 12 + 2 # 16 + 1 # 18	SGRT-3-XX	1 # 14 + 1 # 18 + 1 # 20	SGRT-3-XX
1 # 8 + 1 # 14	SGRT-4-XX	1 # 12 + 2 # 16 + 2 # 18	SGRT-4-XX	1 # 14 + 2 # 18	SGRT-3-XX
1 # 10	SGRT-3-XX	1 # 12 + 3 # 16	SGRT-4-XX	1 # 14 + 3 # 18	SGRT-3-XX
1 # 10 + 1 to 3 # 18	SGRT-3-XX	1 # 12 + 4 # 16	SGRT-4-XX	1 # 14 + 4 # 18	SGRT-3-XX
1 # 10 + 2 # 18	SGRT-3-XX	1 # 12 + 5 # 16	SGRT-4-XX	1 # 14 + 5 # 18	SGRT-4-XX
1 # 10 + 3 # 18	SGRT-4-XX	1 # 12 + 1 # 14 + 1 # 18	SGRT-3-XX	1 # 14 + 1 # 16	SGRT-3-XX
1 # 10 + 1 # 16	SGRT-3-XX	1 # 12 + 1 # 14 + 2 # 18	SGRT-4-XX	1 # 14 + 1 # 16 + 1 # 20	SGRT-3-XX
1 # 10 + 1 # 16 + 1 # 18	SGRT-4-XX	1 # 12 + 1 # 14 + 3 # 18	SGRT-4-XX	1 # 14 + 1 # 16 + 1 # 18	SGRT-3-XX
1 # 10 + 1 # 16 + 2 # 18	SGRT-4-XX	1 # 12 + 1 # 14 + 1 # 16	SGRT-3-XX	1 # 14 + 1 # 16 + 2 # 18	SGRT-3-XX
1 # 10 + 2 # 16	SGRT-4-XX	1 # 12 + 1 # 14 + 2 # 16	SGRT-4-XX	1 # 14 + 1 # 16 + 3 # 18	SGRT-3-XX
1 # 10 + 3 # 16	SGRT-4-XX	1 # 12 + 1 # 14 + 3 # 16	SGRT-4-XX	1 # 14 + 1 # 16 + 4 # 18	SGRT-4-XX
1 # 10 + 4 # 16	SGRT-4-XX	1 # 12 + 1 # 14 + 4 # 16	SGRT-4-XX	1 # 14 + 2 # 16	SGRT-3-XX
1 # 10 + 5 # 16	SGRT-4-XX	1 # 12 + 2 # 14	SGRT-4-XX	1 # 14 + 2 # 16 + 1 # 18	SGRT-3-XX
1 # 10 + 1 # 14	SGRT-3-XX	1 # 12 + 2 # 14 + 1 # 18	SGRT-4-XX	1 # 14 + 2 # 16 + 2 # 18	SGRT-3-XX
1 # 10 + 1 # 14 + 1 # 18	SGRT-4-XX	1 # 12 + 2 # 14 + 1 # 16	SGRT-4-XX	1 # 14 + 2 # 16 + 3 # 18	SGRT-4-XX
1 # 10 + 1 # 14 + 1 # 16	SGRT-4-XX	1 # 12 + 2 # 14 + 2 # 16	SGRT-4-XX	1 # 14 + 3 # 16	SGRT-3-XX
1 # 10 + 1 # 14 + 2 # 16	SGRT-3-XX	1 # 12 + 2 # 14 + 3 # 16	SGRT-4-XX	1 # 14 + 3 # 16 + 1 # 18	SGRT-3-XX
1 # 10 + 1 # 14 + 3 # 16	SGRT-4-XX	1 # 12 + 3 # 14	SGRT-4-XX	1 # 14 + 3 # 16 + 2 # 18	SGRT-4-XX
1 # 10 + 2 # 14	SGRT-4-XX	1 # 12 + 3 # 14 + 1 # 16	SGRT-4-XX	1 # 14 + 4 # 16	SGRT-4-XX
1 # 10 + 3 # 14	SGRT-4-XX	1 # 12 + 4 # 14	SGRT-4-XX	1 # 14 + 4 # 16 + 1 # 18	SGRT-4-XX
1 # 10 + 1 # 12	SGRT-4-XX	2 # 12 + 1 # 18	SGRT-4-XX	1 # 14 + 5 # 16	SGRT-4-XX
1 # 10 + 1 # 12 + 1 # 14	SGRT-4-XX	2 # 12 + 1 # 16	SGRT-4-XX	2 # 14	SGRT-3-XX
1 # 10 + 2 # 12	SGRT-4-XX	2 # 12 + 2 # 16 + 1 # 18	SGRT-4-XX	2 # 14	SGRT-3-XX
2 # 10	SGRT-4-XX	2 # 12 + 3 # 16	SGRT-4-XX	2 # 14	SGRT-3-XX
2 # 10 + 1 # 16	SGRT-4-XX	2 # 12 + 1 # 14 + 1 # 18	SGRT-4-XX	2 # 14	SGRT-3-XX
1 # 12	SGRT-3-XX	2 # 12 + 1 # 14 + 1 # 16	SGRT-4-XX	2 # 14	SGRT-3-XX
1 # 12 + 1 # 18	SGRT-3-XX	2 # 12 + 2 # 14	SGRT-4-XX	2 # 14 + 1 # 16	SGRT-3-XX
1 # 12 + 2 # 18	SGRT-3-XX	3 # 12 + 1 # 18	SGRT-4-XX	2 # 14 + 1 # 16	SGRT-3-XX
1 # 12 + 3 # 18	SGRT-3-XX	3 # 12 + 1 # 16	SGRT-4-XX	2 # 14 + 1 # 16	SGRT-3-XX
1 # 12 + 4 # 18	SGRT-4-XX	3 # 12 + 1 # 14	SGRT-4-XX	2 # 14 + 1 # 16	SGRT-3-XX
1 # 12 + 5 # 18	SGRT-4-XX	1 # 14	SGRT-2-XX	2 # 14 + 2 # 16	SGRT-3-XX
1 # 12 + 1 # 16	SGRT-3-XX	1 # 14 + 1 # 22	SGRT-2-XX	2 # 14 + 2 # 16	SGRT-3-XX
1 # 12 + 1 # 16 + 1 # 18	SGRT-3-XX	1 # 14 + 1 # 20	SGRT-2-XX	2 # 14 + 3 # 16	SGRT-4-XX
1 # 12 + 1 # 16 + 2 # 18	SGRT-3-XX	1 # 14 + 2 # 20	SGRT-3-XX	2 # 14 + 4 # 16	SGRT-4-XX
1 # 12 + 1 # 16 + 3 # 18	SGRT-4-XX	1 # 14 + 3 # 20	SGRT-3-XX	3 # 14	SGRT-3-XX

Table C. SolderGrip Wire Combinations (see Table A for Terminal Size [-XX])
(Continued)

Wire Combinations	Part No.	Wire Combinations	Part No.	Wire Combinations	Part No.
3 # 14 + 1 # 16	SGRT-4-XX	2 # 16 + 4 # 20	SGRT-3-XX	1 # 18 + 1 # 20 + 2 # 22	SGRT-2-XX
3 # 14 + 2 # 16	SGRT-4-XX	2 # 16 + 1 # 18	SGRT-3-XX	1 # 18 + 2 # 20	SGRT-2-XX
3 # 14 + 3 # 16	SGRT-4-XX	2 # 16 + 1 # 18 + 1 # 20	SGRT-3-XX	1 # 18 + 3 # 20	SGRT-2-XX
4 # 14	SGRT-4-XX	2 # 16 + 1 # 18 + 2 # 20	SGRT-3-XX	1 # 18 + 4 # 20	SGRT-3-XX
4 # 14 + 1 # 16	SGRT-4-XX	2 # 16 + 1 # 18 + 3 # 20	SGRT-3-XX	1 # 18 + 5 # 20	SGRT-3-XX
4 # 14 + 2 # 16	SGRT-4-XX	2 # 16 + 2 # 18	SGRT-3-XX	2 # 18	SGRT-2-XX
5 # 14	SGRT-4-XX	2 # 16 + 2 # 18 + 1 # 20	SGRT-3-XX	2 # 18 + 1 # 22	SGRT-2-XX
5 # 14 + 1 # 16	SGRT-4-XX	2 # 16 + 2 # 18 + 2 # 20	SGRT-3-XX	2 # 18 + 1 # 20	SGRT-2-XX
1 # 16	SGRT-2-XX	2 # 16 + 3 # 18	SGRT-3-XX	2 # 18 + 2 # 20	SGRT-3-XX
1 # 16 + 1 # 22	SGRT-2-XX	2 # 16 + 3 # 18 + 1 # 20	SGRT-3-XX	2 # 18 + 3 # 20	SGRT-3-XX
1 # 16 + 2 # 22	SGRT-2-XX	2 # 16 + 4 # 18	SGRT-3-XX	2 # 18 + 4 # 20	SGRT-3-XX
1 # 16 + 3 # 22	SGRT-2-XX	3 # 16	SGRT-3-XX	3 # 18	SGRT-2-XX
1 # 16 + 1 # 20	SGRT-2-XX	3 # 16 + 1 # 20	SGRT-3-XX	3 # 18 + 1 # 20	SGRT-3-XX
1 # 16 + 1 # 20 + 1 # 22	SGRT-2-XX	3 # 16 + 2 # 20	SGRT-3-XX	3 # 18 + 2 # 20	SGRT-3-XX
1 # 16 + 2 # 20	SGRT-2-XX	3 # 16 + 3 # 20	SGRT-3-XX	3 # 18 + 3 # 20	SGRT-3-XX
1 # 16 + 3 # 20	SGRT-3-XX	3 # 16 + 1 # 18	SGRT-3-XX	4 # 18	SGRT-3-XX
1 # 16 + 4 # 20	SGRT-3-XX	3 # 16 + 1 # 18 + 1 # 20	SGRT-3-XX	4 # 18 + 1 # 20	SGRT-3-XX
1 # 16 + 5 # 20	SGRT-3-XX	3 # 16 + 1 # 18 + 2 # 20	SGRT-3-XX	4 # 18 + 2 # 20	SGRT-3-XX
1 # 16 + 1 # 18	SGRT-2-XX	3 # 16 + 2 # 18	SGRT-3-XX	5 # 18	SGRT-3-XX
1 # 16 + 1 # 18 + 1 # 20	SGRT-2-XX	3 # 16 + 2 # 18 + 1 # 20	SGRT-3-XX	5 # 18 + 1 # 20	SGRT-3-XX
1 # 16 + 1 # 18 + 2 # 20	SGRT-3-XX	3 # 16 + 3 # 18	SGRT-3-XX	6 # 18	SGRT-3-XX
1 # 16 + 1 # 18 + 3 # 20	SGRT-3-XX	4 # 16	SGRT-3-XX	1 # 20 + 2 # 22	SGRT-2-XX
1 # 16 + 1 # 18 + 4 # 20	SGRT-3-XX	4 # 16 + 1 # 20	SGRT-3-XX	1 # 20 + 3 # 22	SGRT-2-XX
1 # 16 + 2 # 18	SGRT-3-XX	4 # 16 + 2 # 20	SGRT-3-XX	1 # 20 + 4 # 22	SGRT-2-XX
1 # 16 + 2 # 18 + 1 # 20	SGRT-3-XX	4 # 16 + 1 # 18	SGRT-3-XX	2 # 20	SGRT-2-XX
1 # 16 + 2 # 18 + 2 # 20	SGRT-3-XX	4 # 16 + 1 # 18 + 1 # 20	SGRT-3-XX	2 # 20 + 1 # 22	SGRT-2-XX
1 # 16 + 2 # 18 + 3 # 20	SGRT-3-XX	4 # 16 + 2 # 18	SGRT-4-XX	2 # 20 + 2 # 22	SGRT-2-XX
1 # 16 + 3 # 18	SGRT-3-XX	5 # 16	SGRT-3-XX	2 # 20 + 3 # 22	SGRT-2-XX
1 # 16 + 3 # 18 + 1 # 20	SGRT-3-XX	5 # 16 + 1 # 20	SGRT-4-XX	3 # 20	SGRT-2-XX
1 # 16 + 3 # 18 + 2 # 20	SGRT-3-XX	5 # 16 + 1 # 18	SGRT-4-XX	3 # 20 + 1 # 22	SGRT-2-XX
1 # 16 + 4 # 18	SGRT-3-XX	6 # 16	SGRT-4-XX	4 # 20	SGRT-2-XX
1 # 16 + 4 # 18 + 1 # 20	SGRT-3-XX	1 # 18 + 1 # 22	SGRT-2-XX	5 # 20	SGRT-3-XX
1 # 16 + 5 # 18	SGRT-3-XX	1 # 18 + 2 # 22	SGRT-2-XX	6 # 20	SGRT-3-XX
2 # 16	SGRT-2-XX	1 # 18 + 3 # 22	SGRT-2-XX	4 # 22	SGRT-2-XX
2 # 16 + 1 # 20	SGRT-3-XX	1 # 18 + 1 # 20	SGRT-2-XX	5 # 22	SGRT-2-XX
2 # 16 + 2 # 20	SGRT-3-XX	1 # 18 + 1 # 20 + 1 # 22	SGRT-2-XX	6 # 22	SGRT-2-XX
2 # 16 + 3 # 20	SGRT-3-XX	—	—	—	—

SolderGrip Self-Fixturing Insulated Terminals (Continued)

Installation

The SolderGrip product is pushed onto the conductors with a twisting motion. With the product in place, installation can be completed with the proper selection and use of heating tools and reflectors.

Either of the following Raychem heating tools is recommended:

- HL1802E
- CV-1981

Refer to Raychem installation procedure RPIP 820-01 for detailed instructions and recommended reflector attachments.

You will find ordering information for these tools on pages 9102-9109.

Product Characteristics

Material	
Insulation	Radiation-crosslinked, heat-shrinkable polyvinylidene fluoride (Kynar)
Solder and flux	Sn60 Pb40 with RA flux
Typical Performance	
Contact resistance	4 mΩ after exposure
Tensile strength	Exceeds strength of individual wires
Temperature rating	-55°C to +125°C [-67°F to +257°F]
Insulation resistance	100 megohms

Specifications/Approvals

Series	Agency	Raychem
SGRT	UL and CUL E87681	RB-120

Introduction

Raychem SolderSleeve terminators offer easy, one-step solutions for wire connections to pins, posts, and tabs and for mass wire terminations.

Designed for applications with temperatures up to 150°C [302°F], the products in this section include SolderSleeve discrete wire terminators, which are heat-shrinkable thermoplastic sleeves containing a precisely engineered fluxed solder preform.

SolderSleeve terminators are also available on carrier tape, spaced precisely to match connector terminal spacing, enabling termination of an entire row of wires at one time.

SolderSleeve wire-to-pin, wire-to-post, and wire-to-tab terminators, like all Raychem termination products, provide reliability and economical installation for greater productivity. They can be supplied either in bulk or on carrier tape.

SolderSleeve Discrete Wire Terminators

Product Facts

- Transparent polyvinylidene fluoride or polyolefin insulation sleeve provides encapsulation, inspectability, strain relief, and insulation
- Prefluxed solder preform offers a controlled soldering process
- One-piece design means easy installation and low installed cost
- Optional tape carrier provides convenience and ease of installation
- UL and CUL Recognized 

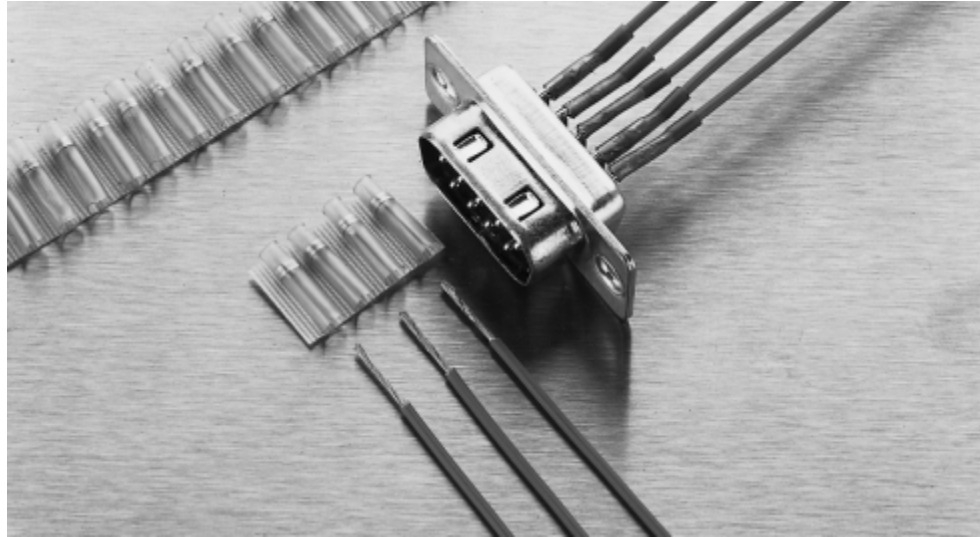

Applications

Used for terminating wires to component terminals, such as motor tabs, connector pins, and switch terminals.

Product selection process

1. Determine the application operating temperature.
2. From the Product Options table on the next page, select the product series appropriate for the application, based on the temperature required.
3. Determine your component connection point type (pin, post, or tab) and dimensions.
4. Determine your wire gauge.
5. Optional: Select tape carrier center-to-center spacing (D-71X series only). This should match center spacing of component terminals.
6. Select part number from the appropriate table:
 - For CWT series (applications with low-temperature wires—below 125°C [257°F]), use Table A.
 - For D-129/141/71X series (applications with wires rated higher than 125°C [257°F]), use Table B.

Installation

For proper installation of these devices, the correct heating tool and reflector attachment must be used. Either of the following Raychem heating tools are recommended:

- HL1802E
 - AA-400 Super Heater
- Refer to Raychem installation procedure RCPS 200-12 (for D-129, D-141, D-71X) or RPIP 824-00 (for CWT) for detailed instructions and recommended reflector attachment.

You will find ordering information for these tools on pages 9102-9109.

SolderSleeve Discrete Wire Terminators (Continued)

Product Options

Product Series	Max. Operating Temperature	Min. Wire Temperature Rating
CWT	125°C [257°F]	85°C [185°F]
D-129, D-141, D-71X	150°C [302°F]	125°C [257°F]

Table A. CWT Series
(125°C [257°F] rated)

Connection-point Type and Size	Terminal Dimensions	Wire AWG/mm ²	Part No.
 <p>pin</p>	W = up to 0.63 [.025]	24 [0.24] 20 [0.61]	CWT-1501 CWT-1502
	W = 0.63 [.025] to 0.89 [0.35]	24 [0.24] 22 [0.38] 20 [0.61]	CWT-1501 CWT-1502 CWT-1503
 <p>post</p>	W = 0.89 [0.35] to 1.14 [.045]	24-22 [0.24-0.38] 20-18 [0.61-0.95]	CWT-1502 CWT-1503
	W = 1.14 [.045] to 1.52 [.060]	24-22 [0.24-0.38] 20-18 [0.61-0.95]	CWT-1503 CWT-1504
 <p>tab</p>	W = up to 1.52 [.060]	24-20 [0.24-0.61]	CWT-1501
	W = 1.27 [.050] to 2.28 [.090]	24-18 [0.24-0.95]	CWT-1502
	W = 1.77 [.070] to 2.79 [.110]	24-18 [0.24-0.95]	CWT-1503
	W = 2.54 [.100] to 3.80 [.150]	24-18 [0.24-0.95]	CWT-1504
	W = 2.28 [.090] to 4.70 [.187]	22-16 [0.38-1.21]	CWT-1505

Table B. D-129/141/71X Series
(up to 150°C [302°F] rated)

Connection-point
Type and Size

Terminal Dimensions		Wire		Tape Carrier Spacing of Sleeves (Center-to-Center)				
		AWG	mm ²	None	1.27 [0.050]	2.76 [0.100]	3.17 [0.125]	4.0 [0.156]
 pin	W = up to 0.61 [.024]	30–26	[0.05–0.15]	D-141-30	D-713-03	—	—	—
	W = 0.63 [.025] to 0.81 [.032]	24–22	[0.24–0.38]	D-141-07	—	D-711-00	—	—
 post	W = 0.76 [.030] to 1.27 [.050]	20	[0.61]	D-141-31	—	D-711-04	D-711-07	D-711-08
	W = up to 1.52 [.060]	24–20	[0.24–0.61]	D-141-56	—	—	—	—
 tab	W = 1.27 [.050] to 2.28 [.090]	24–20	[0.24–0.61]	D-129-05	—	D-714-01	—	—
	W = 2.28 [.090] to 3.55 [.140]	24–20	[0.24–0.61]	D-129-03	—	—	—	D-714-00

For Fine Wire Terminations
0.15 mm² (26 AWG) and
Smaller*

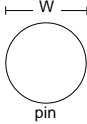
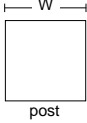
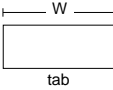
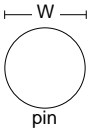
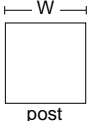
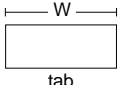
Part No.*	Inside Diameter As Supplied**	Fully Recovered†	Length††
D-110-0062	1.0 [0.040]	0.6 [0.025]	16.0 [0.630]
D-110-0217	1.0 [0.040]	0.6 [0.025]	9.0 [0.360]
D-141-13	0.75 x 1.65 [0.030 X 0.065]	0.75 [0.030]	4.7 [0.185]
D-141-22	0.75 x 1.65 [0.030 X 0.065]	0.75 [0.030]	6.0 [0.240]
D-141-30	0.75 x 1.65 [0.030 X 0.065]	0.75 [0.030]	9.5 [0.375]

Note: Micro SolderSleeve terminators are used for attaching leads smaller than 26 AWG (0.15 mm²) to terminals less than 0.6 [.025] wide.

*The D-110 series sleeves are primarily for single wire terminations and do not have a wire stop. The D-141 series will accept either one or two wires; the parts have a built-in wire stop that will locate the wire approximately 0.76 [0.03] from bottom of terminal.

**Minimum. Wire insulation must be smaller than this. When using the D-141 parts for two-wire terminations, the combined wire insulation diameters must be less than 1.5 [.060].

†Maximum. The combination of conductor diameter and terminal width and the wire insulation must be greater than this.

††The terminal length should be at least 1.2 [0.05] shorter than this. The wire strip length must be adjusted so that, when terminated, the exposed conductor is covered by the sleeve.

Product Characteristics

SolderSleeve Discrete Wire Terminators (Continued)

Material	
Insulation [D-129, D-141, D-71X]	Radiation-crosslinked, heat-shrinkable polyvinylidene fluoride
Insulation [CWT]	Radiation-crosslinked, heat-shrinkable polyolefin
Solder and flux [D-129, D-141, D-71X]	Solder: Sn63 Pb37 Flux: ROL1 per ANSI -J - 004 [RMA flux]
Solder and flux [CWT]	Solder: Sn50 Pb32 Cd 18 Flux: ROM1 per ANSI -J - 004 [RA flux]
Typical Performance	
Voltage drop	2.0 mV
Tensile strength	Exceeds strength of conductor
Dielectric strength	2.0 kV
Temperature rating [CWT]	-55°C to 125°C [-67°F to 257°F]
Temperature rating [D-129, D-141, D-71X]	-55°C to 150°C [-67°F to 302°F]
Insulation resistance	1000 megohms

Specifications/Approvals

Series	Agency	Raychem
CWT	UL and CUL E87681	D-5023
D-129, D-141	UL and CUL E87681	RT-1404

Introduction

Raychem SolderSleeve shield grounding terminators provide an environmentally sealed, insulated, and encapsulated solder connection for a variety of applications. SolderSleeve terminators are available in many styles.

Designed for a wide variety of temperature applications ranging from -65°C to 200°C [-85°F to 392°F], the products in this section include:

- CWT-X SolderSleeve terminators, designed for low-temperature cables with operating temperatures up to 125°C [257°F] and suitable for most commercial environments.
- MIL-S-83519 SolderSleeve terminators, which are immersion resistant and available with or without a preinstalled ground lead.
- SO Seies SolderSleeve terminators, which also are immersion resistant and feature the Raychem BiAlloy temperature indication system.

All SolderSleeve products are reliable, versatile, and easy to install, resulting in lower installed costs.

SolderSleeve Shield Terminators

Product Facts

- Transparent insulation sleeve provides encapsulation, inspectability, strain relief, and insulation
- Prefluxed solder preform provides a controlled soldering process
- One-piece design offers easy installation and lower installed cost
- Optional preinstalled ground leads provide convenience and ease of installation

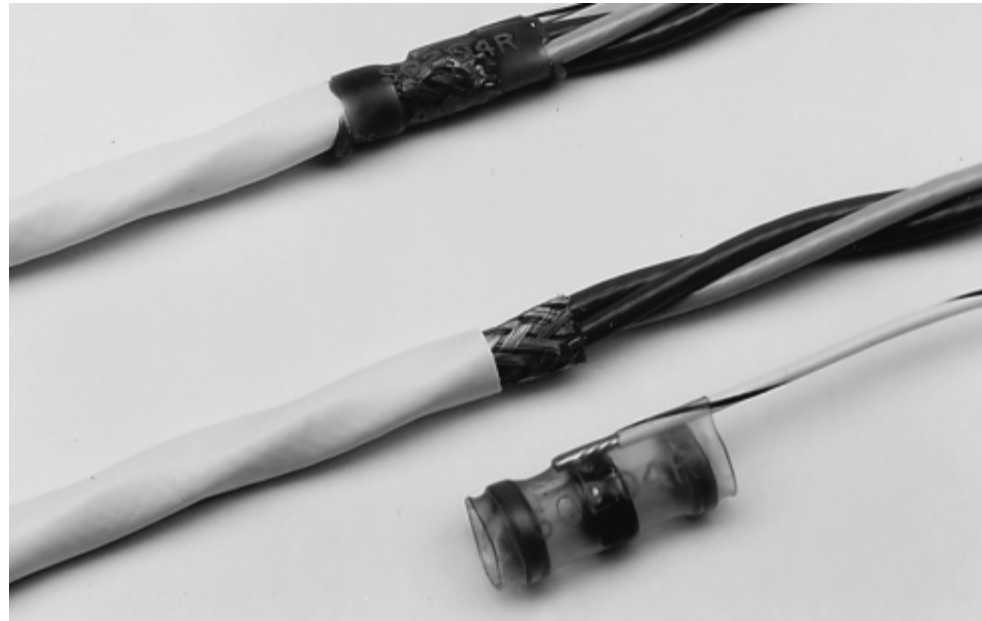

Applications

Used for shield-to-ground termination.

Product Selection Process

1. Select product series from the Product Options table below.
2. Determine cable dimensions.
3. Optional: Select pre-installed wire lead type (see Table E on page 9089 for type descriptions).
4. Select part number (use the selection table indicated for your product series in the Product Options table below).
5. Refer to Table F on page 9091 for supersession and cross-reference information.

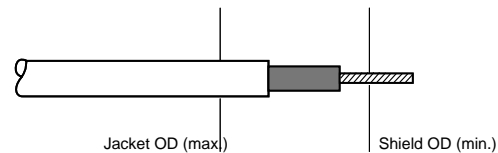

Product Options (Refer to Table E on Page 9088 for Additional Information)

Product Series	System Oper. Temperature (Max.)	Used on Cables Rated (Min.)	Environmental Protection	Solder Alloy	Flux Type	Insulation Material	Part No. Selection Table
CWT	125°C [257°F]	85°C [185°F]	Splash resistant	Cd18	RA	Polyolefin	A
SO63*	150°C [302°F]	125°C [257°F]	Immersion resistant	Sn63	RMA	Polyvinylidene fluoride	B
S01/S02**	150°C [302°F]	125°C [257°F]	Immersion resistant	Sn63	RMA	Polyvinylidene fluoride	C
SO96***	175°C [347°F]	150°C [302°F]	Immersion resistant	Sn96	RA	Polyvinylidene fluoride	D

*Meets performance requirements of MIL-S-83519 and NAS 1747, supplied with BiAlloy temperature indicator.

**Qualified to MIL-S-83519, supplied with thermochromic temperature indicator.

***Meets performance requirements of MIL-S-83519 and NAS 1747, supplied with thermochromic temperature indicator.

SolderSleeve Shield Terminators (Continued)

Table A. CWT Series
(125°C [257°F] rated)

Cable OD		Part Nos.	
Jacket OD Max.	Shield OD Min.	No Preinstalled Lead	With Preinstalled Lead (22AWG/0.38 mm² green)
1.7 [.065]	0.9 [.035]	CWT-3801	—
1.95 [.075]	1.15 [.045]	CWT-3802	—
2.7 [.105]	1.8 [.070]	CWT-3	CWT-3-W122-5
4.5 [.180]	2.3 [.090]	CWT-5	CWT-5-W122-5
6.0 [.235]	3.3 [.130]	CWT-6	CWT-6-W122-5
7.0 [.275]	3.7 [.145]	CWT-7	CWT-7-W122-5
8.7 [.340]	4.2 [.165]	CWT-9	CWT-9-W122-5
10.7 [.420]	7.1 [.280]	CWT-11	CWT-11-W122-5
13.0 [.510]	8.9 [.350]	CWT-13	CWT-13-W122-5

*See Table E on page 9089 for lead description.

Note: The CWT series is suitable for applications using low-temperature wires (typically rated at 85°C [185°F] to 125°C [257°F]) with bare copper or tin plating.

Table B. SO63 Series

BiAlloy Temperature Indication System

This system greatly enhances the reliability and repeatability of SO63 series terminators while reducing installed cost. The heat-shrinkable thermoplastic sleeve contains a precisely engineered, fluxed solder band that is visible through the sleeve. The band provides exactly the amount of solder and flux required to terminate the ground lead to the cable shield.

Encircling the band is a small temperature indicator ring. This ring melts only when the surfaces to be joined have reached the correct soldering temperature, thus ensuring a properly soldered connection. Process control is built into each sleeve.

Cable OD		Part Nos.					
Jacket OD Max.	Shield OD Min.	No Preinstalled Lead	Preinstalled Lead Option*				Braid Strap
			20 AWG	22 AWG	24 AWG	26 AWG	
1.95 [0.075]	0.90 [.035]	SO63-1-00	SO63-1-55-20-90	SO63-1-55-22-90	SO63-1-55-24-90	SO63-1-55-26-90	SO63-1-01
2.7 [0.105]	1.40 [.055]	SO63-2-00	SO63-2-55-20-90	SO63-2-55-22-90	SO63-2-55-24-90	SO63-2-55-26-90	SO63-2-01
4.3 [0.170]	2.15 [.085]	SO63-3-00	SO63-3-55-20-90	SO63-3-55-22-90	SO63-3-55-24-90	SO63-3-55-26-90	SO63-3-01
6.0 [0.235]	3.30 [.130]	SO63-4-00	SO63-4-55-20-90	SO63-4-55-22-90	SO63-4-55-24-90	SO63-4-55-26-90	SO63-4-01
7.0 [0.275]	4.30 [.170]	SO63-5-00	SO63-5-55-20-90	SO63-5-55-22-90	SO63-5-55-24-90	SO63-5-55-26-90	SO63-5-01

*See Table E on page 9089 for lead description. Color of wire lead is denoted by the last two digits of the part number as follows:

90 = White with a black stripe 9 = White 0 = Black 6 = Blue (24 AWG only) 5 = Green (20, 22, 24 AWG)

The SO63 series is immersion resistant, features the Raychem BiAlloy temperature indication system, and meets the performance requirements of MIL-S-83519.

Table C. S01/S02 M83519 Series

SolderSleeve Shield Terminators (Continued)

Thermochromic Temperature Indicator

The M83519 (S01 and S02) series terminators contain a colored thermochromic temperature indicator that exhibits a distinct color change when surfaces have reached wetting temperature. This color change gives both manufacturing and Quality Control an aid in the inspection of the completed termination.

Cable OD		Part No. (MIL Part Number and Raychem Part No.) by Lead Option					
Jacket OD Max	Shield OD Min	No Preinstalled Lead		Preinstalled Lead Option*			
		MIL	Raychem	20 AWG		22 AWG	
				MIL	Raychem	MIL	Raychem
1.95 [0.075]	0.9 [.035]	M83519/1-1	S01-01-R	M83519/2-1	S02-01-R	M83519/2-6	S02-06-R
2.7 [0.105]	1.40 [.055]	M83519/1-2	S01-02-R	M83519/2-2	S02-02-R	M83519/2-7	S02-07-R
4.3 [0.170]	2.15 [.085]	M83519/1-3	S01-03-R	M83519/2-3	S02-03-R	M83519/2-8	S02-08-R
6.0 [0.235]	3.30 [.130]	M83519/1-4	S01-04-R	M83519/2-4	S02-04-R	M83519/2-9	S02-09-R
7.0 [0.275]	4.30 [.170]	M83519/1-5	S01-05-R	M83519/2-5	S02-05-R	M83519/2-10	S02-10-R
Jacket OD Max.	Shield OD Min.	Preinstalled Lead Option*					
				24 AWG		26 AWG	
1.95 [0.075]	0.9 [.035]			M83519/2-11	S02-11-R	M83519/2-16	S02-16-R
2.7 [0.105]	1.40 [.055]			M83519/2-12	S02-12-R	M83519/2-17	S02-17-R
4.3 [0.170]	2.15 [.085]			M83519/2-13	S02-13-R	M83519/2-18	S02-18-R
6.0 [0.235]	3.30 [.130]			M83519/2-14	S02-14-R	M83519/2-19	S02-19-R
7.0 [0.275]	4.30 [.170]			M83519/2-15	S02-15-R	M83519/2-20	S02-20-R

*See Table E for lead description.

M83519 is the qualified product listed in MIL-S-83519. The series features a thermochromic temperature indicator to assist in termination and inspection. The Raychem part number is permanently marked on the sleeve.

Table D. SO96 Series
(175°C [347°F] rated)

SolderSleeve Shield Terminators (Continued)

**Thermochromic
Temperature Indicator**

The SO96 series terminators contain a colored thermochromic temperature indicator that exhibits a distinct color change when surfaces have reached wetting temperature. This color change gives both manufacturing and Quality Control an aid in the inspection of the completed termination.

Cable OD		Part No.		
Jacket OD Max.	Shield OD Min.	No Preinstalled Lead	Preinstalled Lead Option*	
			22 AWG	Braid Strap
1.95 [0.075]	0.9 [.035]	SO96-1-00	SO96-1-55-22-90	SO96-1-01
2.7 [0.105]	1.40 [.055]	SO96-2-00	SO96-2-55-22-90	SO96-2-01
4.3 [0.170]	2.15 [.085]	SO96-3-00	SO96-3-55-22-90	SO96-3-01
6.0 [0.235]	3.30 [.130]	SO96-4-00	SO96-4-55-22-90	SO96-4-01
7.0 [0.275]	4.30 [.170]	SO96-5-00	SO96-5-55-22-90	SO96-5-01

*See Table E for lead description.
The SO96 series is designed for high-temperature applications with operating temperature requirements up to 200°C [392°F]. This series features a thermochromic temperature indicator and meets performance requirements of MIL-S-83519. The solder is Sn96 with RA flux compatible with nickel-plated shields.

Table E. Preinstalled Lead
Description

Series	Lead Type	Remarks	Plating	Stranding	Min. Length
M83519, SO63	55A0111	MIL-W-22759/32	Tin	Stranded	150 [6.00]
SO96	55A0813	MIL-W-22759/41	Nickel	Stranded	150 [6.00]
SO63, SO96	Braid strap	Uninsulated	Nickel	40 x 38 AWG	150 [6.00]
CWT	XL polyethylene	UL Listed	Tin	Stranded (W1)	150 [6.00]

Product Characteristics

Shield Termination

Solder Sleeve Shield Terminators (Continued)

Material		
Insulation		
SO, M83519	Radiation-crosslinked, heat-shrinkable polyvinylidene fluoride	
CWT	Radiation-crosslinked, heat-shrinkable polyolefin	
Solder and flux		
SO63, M83519	Solder: Sn63 Pb37	Flux: ROL1 per ANSI - J - 004 (RMA Flux)
SO96 series	Solder: Sn96 Ag4	Flux: ROM1 per ANSI - J - 004 (RA Flux)
CWT	Solder: Sn50 Pb32 Cd18	Flux: ROM1 per ANSI - J - 004 (RA Flux)
Ground lead		
CWT series	XL polyethylene	
SO, M83519	MIL-W-22759/32 or /41	
Typical Performance		
Voltage drop	2.5 mV	
Tensile strength	Exceeds strength of ground lead	
Dielectric strength	1.0 kV immersed	
Temperature rating		
CWT	-55°C to 125°C [-67°F to 257°F]	
SO63/M83519	-55°C to 150°C [-67°F to 302°F]	
SO96 series	-55°C to 175°C [-67°F to 347°F]	
Insulation resistance	1000 megohms	

Specifications/Approvals

Series	Agency	Raychem
CWT	—	D-5023
SO63*	NAS 1747	RT-1404
M83519**	MIL-S-83519/1&2	RT-1404
SO96***	NAS 1747	RT-1404

*Meets performance requirements of MIL-S-83519 and NAS 1747, supplied with BiAlloy temperature indicator.

**Qualified to MIL-S-83519, supplied with thermochromic temperature indicator.

***Meets performance requirements of MIL-S-83519 and NAS 1747, supplied with thermochromic temperature indicator.

Installation

For proper installation of these devices, the correct heating tool and reflector attachment must be used. Any one of the following Raychem heating tools is recommended:

- HL1802E
- AA-400 Super Heater
- CV-1981
- MiniRay
- IR-1759

For detailed instructions and recommended reflector attachments, refer to the appropriate Raychem installation procedure:

- Series Procedure**
- CWT RPIP 655-00-D**
- SO63 RCPS 100-70**
- M83519 (S01/S02) RCPS 100-70**
- SO96 RCPS 100-70**

You will find ordering information for these tools on pages 9102-9109.

Table F. Inactive NAS Part and Cross-Reference

Inactive NAS Part No.	Military Part No.	Raychem S01/S02* Series	Raychem SO63** Series	D-1XX Series	NAS Series
1745-1	M83519/1-1	S01-01-R	SO63-1-00	D-144-25	—
1745-2	M83519/1-2	S01-02-R	SO63-2-00	D-100-00	—
1745-3	M83519/1-3	S01-03-R	SO63-3-00	D-101-00	—
1745-17	M83519/1-4	S01-04-R	SO63-4-00	D-107-00	—
1745-4	M83519/1-5	S01-05-R	SO63-5-00	D-103-00	—
1745-9	—	—	—	—	NAS1745-13
1745-10	—	—	—	—	NAS1745-14
1745-11	—	—	—	—	NAS1745-15
1745-12	—	—	—	—	NAS1745-16
1745-13***	M83519/1-1	—	—	D-142-83***	—
1745-14***	M83519/1-2	—	—	D-142-50***	—
1745-15***	M83519/1-3	—	—	D-142-51***	—
1745-23***	M83519/1-4	—	—	D-142-56***	—
1745-16***	M83519/1-5	—	—	D-142-52***	—
1746-1	M83519/1-1	S01-01-R	SO63-1-00	D-144-25	—
1746-2	M83519/1-2	S01-02-R	SO63-2-00	D-144-00	—
1746-3	M83519/1-3	S01-03-R	SO63-3-00	D-144-01	—
1746-9	M83519/1-4	S01-04-R	SO63-4-00	D-144-46	—
1746-4	M83519/1-5	S01-05-R	SO63-5-00	D-144-02	—
—	M83519/2-1	S02-01-R	SO63-1-55-20-90	—	—
—	M83519/2-2	S02-02-R	SO63-2-55-20-90	—	—
—	M83519/2-3	S02-03-R	SO63-3-55-20-90	—	—
—	M83519/2-4	S02-04-R	SO63-4-55-20-90	—	—
—	M83519/2-5	S02-05-R	SO63-5-55-20-90	—	—
—	M83519/2-6	S02-06-R	SO63-1-55-22-90	—	—
—	M83519/2-7	S02-07-R	SO63-2-55-22-90	—	—
—	M83519/2-8	S02-08-R	SO63-3-55-22-90	—	—
—	M83519/2-9	S02-09-R	SO63-4-55-22-90	—	—
—	M83519/2-10	S02-10-R	SO63-5-55-22-90	—	—
—	M83519/2-11	S02-11-R	SO63-1-55-24-90	—	—
—	M83519/2-12	S02-12-R	SO63-2-55-24-90	—	—
—	M83519/2-13	S02-13-R	SO63-3-55-24-90	—	—
—	M83519/2-14	S02-14-R	SO63-4-55-24-90	—	—
—	M83519/2-15	S02-15-R	SO63-5-55-24-90	—	—
—	M83519/2-16	S02-16-R	SO63-1-55-26-90	—	—
—	M83519/2-17	S02-17-R	SO63-2-55-26-90	—	—
—	M83519/2-18	S02-18-R	SO63-3-55-26-90	—	—
—	M83519/2-19	S02-19-R	SO63-4-55-26-90	—	—
—	M83519/2-20	S02-20-R	SO63-5-55-26-90	—	—

*QPL listed to MIL-S-83519. **Meets performance requirements of MIL-S-83519.
 ***The CWT series is the recommended replacement.

Introduction

Raychem SolderSleeve coaxial cable terminators allow reliable, easy terminations in a variety of coaxial cable applications, including printed circuit boards (PCBs). The insulating and strain-relieving capabilities of SolderSleeve terminators provide the ideal solution to center-conductor breakage problems.

Designed for applications with temperatures up to 150°C [302°F], the products in this section include:

- SolderSleeve coaxial cable terminators, which allow reliable, economical attachment of coaxial cable to connector terminals, printed wiring assemblies, or solderless wrap terminals.
- One-piece SolderSleeve PCB coaxial cable terminators, which permit quick, easy, and cost-effective terminations of coaxial cable to printed circuit boards.
- RF one-step BNC/TNC connectors, which are single-piece assemblies for terminating the center conductor and the braid of a broad range of coaxial cables. They are fully intermateable with MIL-C-39012C connectors and are available in 50-ohm and 75-ohm versions (refer to pages 7034-7039 in Section 7 for product information).

With precisely measured solder and flux, SolderSleeve products provide exact process control of terminations. The SolderSleeve method means strong connections with the lowest possible voltage drop. Small, lightweight SolderSleeve terminators are also the ideal solution for high-density packaging problems.

Product Facts

- Transparent polyvinylidene fluoride or polyolefin insulation sleeve provides encapsulation, inspectability, strain relief (eliminates center conductor breakage), and insulation.
- Prefluxed solder preform provides a controlled soldering process
- One-piece design provides easy installation and lower installed cost
- Preinstalled termination leads provide convenience and ease of installation

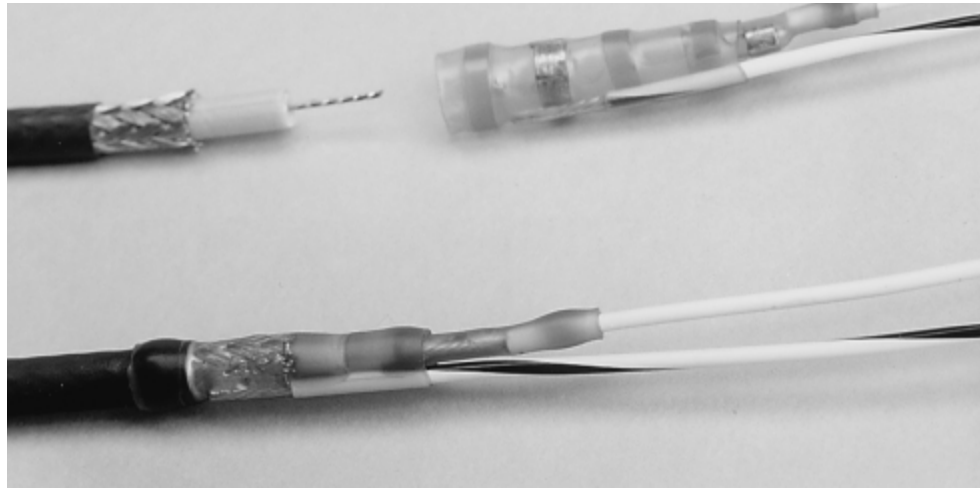

Applications

Used for terminating coaxial cable to component terminals, contacts, printed circuit boards, and solderless wrap terminals.

Product Selection Process

1. Select product series from the product options table below.
2. Select preinstalled lead type from the table below.
3. Determine cable RG number or dimensions.
4. Select part number from Table A (CWT series) or Table B (B-02X/B-04X series) on the next page.

Product Options

Product Series	Max. Operating Temp.	Use on Cables Rated (Min)	Cable Shield Plating	Part No. Selection Table
CWT	125°C [257°F]	85°C [185°F]	Tin, copper	A
B-02X/B-04X	150°C [302°F]	125°C [257°F]	Tin, silver	B

Preinstalled Lead Descriptions

Series	Lead Type	Plating	Stranding	AWG	Length	Color
CWT	XL polyethelene	Tin	Stranded (W1)	22	150 [6.000]	White (cntr), green (grnd)
B-021	M81822/13 (solderless wrap)	Silver	Solid-OFHC	24—30	150 [6.000]	White (cntr), blue (grnd)
B-041	M81822/13 (solderless wrap)	Silver	Solid-OFHC	24—30	150 [6.000]	White (cntr), blue (grnd)
B-043	M81822/13 (solderless wrap)	Silver	Solid-OFHC	24—30	150 [6.000]	White (cntr), blue (grnd)
B-020	55A0111 (MIL-W-22759/32)	Tin	Stranded	20—30	150 [6.000]	White (cntr), blue (grnd)
B-040	55A0111 (MIL-W-22759/32)	Tin	Stranded	20—30	150 [6.000]	White (cntr), blue (grnd)
B-044	55A0111 (MIL-W-22759/32)	Tin	Stranded	20—30	150 [6.000]	White (cntr), blue (grnd)

Table A. CWT Series Part Numbers

Cable RG Number	Dimensions		Part No. With Preinstalled Lead (22 AWG/0.38 mm² Green/White)
	Dielectric OD	Jacket OD	
174	0.80–2.30 [.032–.091]	1.30–2.80 [.051–.110]	CWT-4174-W122-5/9
58, 122	2.00–2.80 [.079–.110]	2.50–4.40 [.100–.173]	CWT-4058-W122-5/9
59	2.80–3.30 [.110–.130]	3.20–6.00 [.125–.235]	CWT-4059-W122-5/9

Table B. B-02X/B-04X Series Part Numbers

SolderSleeve Coaxial Cable Terminators (Continued)

Part 1: Coaxial Product Group Selection

Typical Compatible Part No.		Dimension Range					One-Piece Coaxial Product Group
RG Cable Number	Raychem Cable Description	Jacket OD (Max.)	Shield OD	Dielectric OD	Conductor OD		
RG178, RG404	5030A13XX 5028A13XX	3.40 [.134]	1.30–2.30 [.051–.091]	0.50–1.70 [.019–.067]	0.30–0.80 [.011–.032]	Group 1	
RG179, RG316	5024A13XX 7530A13XX 7526A13XX 9530A13XX	4.40 [.173]	1.50–2.80 [.060–.110]	1.20–2.50 [.047–.100]	0.30–1.60 [.011–.063]	Group 2	
RG180, RG302, RG303	9527A13XX 9528A13XX	6.30 [.248]	2.40–4.60 [.094–.181]	1.40–4.30 [.055–.169]	0.30–2.80 [.011–.110]	Group 3	

Part 2: Product Part Number Selection

One-Piece Coaxial Product Group	Preinstalled Wire Type	Preinstalled Wire Size					
		20 AWG	22 AWG	24 AWG	26 AWG	28 AWG	30 AWG
Group 1	Stranded (M22759)	—	B-044-22-N	B-044-24-N	B-044-26-N	—	—
	Solid (M81822)	—	—	B-043-24-N	B-043-26-N	B-043-28-N	B-043-30-N
Group 2	Stranded (M22759)	B-040-20-N	B-040-22-N	B-040-24-N	B-040-26-N	B-040-28-N	B-040-30-N
	Solid (M81822)	—	—	B-041-24-N	B-041-26-N	B-041-28-N	B-041-30-N
Group 3	Stranded (M22759)	B-020-20-N	B-020-22-N	B-020-24-N	B-020-26-N	—	—
	Solid (M81822)	—	—	—	B-021-26-N	—	—

1. The B-02X/B-04X series uses a one-piece design to terminate coaxial cables rated at 125°C minimum.
2. Using Part 1 of this table, select the appropriate coaxial product group (1, 2, or 3) based on your RG cable number, Raychem cable description, or cable dimensions.
3. Using Part 2 of this table, select the product part number based on the coaxial product group you selected in Part 1 and the appropriate preinstalled lead type you selected on the previous page.

Product Characteristics

Material	
Insulation (B-02X/B-04X)	Radiation-crosslinked, heat-shrinkable polyvinylidene fluoride (Kynar)
Insulation (CWT series)	Radiation-crosslinked, heat-shrinkable polyolefin
Solder and flux (B-02X/B-04X)	Solder: Sn63 Pb37 Flux: ROL1 per ANSI-J-004 (RMA Flux)
Solder and flux (CWT series)	Solder: Sn50 Pb32 Cd18 Flux: ROM1 per ANSI-J-004 (RA Flux)
Typical Performance	
Voltage drop	2.0 mV
Tensile strength	Exceeds strength of conductor
Dielectric strength	2.0 kV
Temperature rating (CWT)	-55°C to 125°C [-67°F to 257°F]
Temperature rating (B-02X/B-04X)	-55°C to 150°C [-67°F to 302°F]
Insulation resistance	1000 megohms

SolderSleeve PCB/Coaxial Cable Terminators

Product Facts

- Provides a completely shielded, low-resistance, matched-impedance termination with very low VSWR (D-607 series only)
- Transparent polyvinylidene fluoride insulation sleeve provides encapsulation, inspectability, strain relief, and insulation
- Prefluxed solder preform provides a controlled soldering process
- One-piece design offers easy installation and lower installed cost
- Preinstalled PCB termination body provides convenience and ease of installation

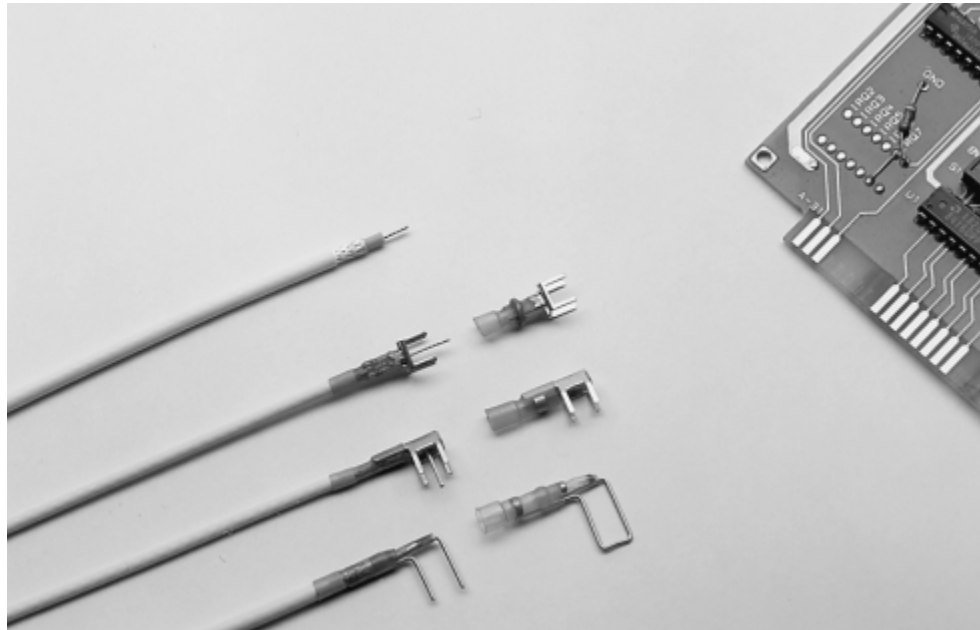

Applications

Used for terminating coaxial cable to printed circuit boards.

Installation

For proper installation of these devices, the correct heating tool and reflector attachment must be used. Any one of the following Raychem heating tools is recommended:

- HL1802E
- AA-400 Super Heater
- IR-1759 MiniRay
- CV-1981

Refer to Raychem installation procedure ES61139 for detailed instructions and recommended reflector attachments.

You will find ordering information for these tools on pages 9102-9109.

Product Selection Process

1. Select product series from the Product Options table below.
 2. Determine cable RG number or outside diameter dimensions.
 3. Select the appropriate part number from Table A (D-607 series) or Table B (B-046 series).
- For D-607 (matched impedance) series, determine straight or right-angle entry to PCB and grid pattern, then select the appropriate part number from Table A on the next page.
 - For B-046 (PinPak, or pin to ground) series, determine hole spacing and diameter. Refer to Table B for product selection (see illustration below for cable dimensions).

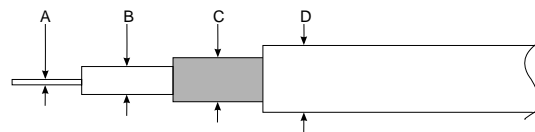

Product Options

Product Series	Typical Application Performance	Shield Method	Part No. Selection Table
D-607	Matched impedance up to 2.3 GHz	Metal body	A
B-046	Effective transmission up to 100 MHz	Pin to ground	B

Specifications/Approvals

Series	Raychem
D-607	RT-1404
B-046	RT-1404

Table A. D-607 Series Part Numbers

RG Cable No.	Cable Dimensions (mm/in) Max. Outside Diameter			Part No. Entry to PCB		
	Jacket	Shield	Dielectric	Straight grid 5.08 [.200]	Right-Angle Grid 5.08 [.200]	Straight Grid 2.54 [.100]
174, 178, 179, 316, 404	1.5–3.55 [.060–.140]	1.1–3.15 [.045–.125]	0.60–2.25 [.025–.090]	D-607-09	D-607-10	D-607-40*

Table B. B-046 Series Part Numbers

RG Cable No.	Cable Dimensions				Pin Diameter	Spacing Between Pins 2.54 [.100]	Part No.	
	A	B	C	D Max.			5.08 [.200]	6.35 [.250]
178, 404	0.30–0.80 [.011–.032]	0.5–1.7 [.019–.067]	1.3–2.3 [.050–.091]	3.4 [.134]	0.6 [.023] 0.8 [.031]	B-046-14-N	B-046-10-N B-046-11-N	B-046-12-N B-046-13-N
179, 316	0.3–1.6 [.011–.063]	1.2–2.5 [.047–.100]	1.5–2.8 [.060–.110]	4.4 [.173]	0.6 [.023] 0.8 [.031]	B-046-15-N	B-046-66-N B-046-68-N	B-046-16-N B-046-18-N

Product Characteristics

Material		
Insulation	Radiation-crosslinked, heat-shrinkable polyvinylidene fluoride	
Solder and flux	Solder: Sn63 Pb37 Flux: ROL1 per ANSI - J - 004 (RMA flux)	
Termination body/pin	Copper alloy, solder-plated	
Typical Performance		
Voltage drop	2.0 mV	
Tensile strength	Exceeds strength of conductor	
Dielectric strength	2.0 kV	
Temperature rating	-55°C to 150°C [-67°F to 302°F]	
Insulation resistance	1000 megohms	
Electrical Performance (typical) D-607 Series Only		
Frequency	VSWR (D-607-09, -40)	VSWR (D-607-10)
350 MHz	1.04 max.	1.04 max.
700 MHz	1.05 max.	1.09 max.
2.3 GHz	1.09 max.	1.12 max.

Introduction

The question is, how to meet growing performance requirements for shielded cable system fabrication and maintenance while minimizing electromagnetic interference (EMI). The answer is Raychem SolderShield cable splices. SolderShield devices are one-piece products consisting of a flux-coated, solder-impregnated copper shield braid encased in a heat-shrinkable insulation sleeve.

SolderShield cable-to-cable splice kits, designed for single-conductor or multi-conductor shielded cables, are ideal for fabrication/repair/rework while restoring the electrical integrity of the cable.

SolderShield devices perform even in demanding environments. They are reliable, versatile, and easy to install.

SolderShield Shielded and Coaxial Cable Splices

Product Facts

- Flux-coated, solder-impregnated copper shield braid encased in a transparent heat-shrinkable insulation sleeve provides a controlled soldering process, encapsulation, inspectability, strain relief, and insulation
- One-piece design provides easy installation and lower installed cost
- Circumferential (360°) shielding results in EMI protection and shield continuity equal to or better than the original cable
- Conductor splices are made using Raychem MiniSeal crimp products, which are recognized by MIL-S-81824 and MIL-W-5088



Applications

Used for splicing a wide range of cables, including coaxial and multiconductor cables.

SolderShield devices can be used to repair or splice shielded or coaxial cables. These products consist of a MiniSeal crimp splice plus a flux-coated, solder-impregnated copper shield encased in a heat-shrinkable sealing sleeve, for splicing the shields. SolderShield kits terminate single- or multiple-conductor cables, eliminate EMI problems at the splice, and provide strain relief for the cable.

Product Selection Process

For splicing multiconductor cables refer to Table A.

For splicing coaxial cables refer to Table B.

Installation

For proper installation of these devices, the correct heating tool and reflector attachment must be used. Any one of the following Raychem heating tools is recommended:

- HL1802E
- IR-1759 MiniRay
- CV-1981

The HT-900B heating tool is designed for use in field applications.

Refer to Raychem installation procedure RCPS 150-02 (D-150 series) and RPIP 699-00 (B-202 series) for detailed instructions and recommended reflector attachment.

You will find ordering information for most of these tools on pages 9102-9109.

Specifications/Approvals

Series	Military	Raychem
D-150	US: M81824 (conductor splice only) UK: RAF AP 1130-2008-1	RT-1404

SolderShield Shielded and Coaxial Cable Splices (Continued)

Table A. Multiconductor Cable Splices

Each SolderShield part consists of a SolderShield splice and one or more conductor splices. Refer to information below for description and numbers of conductor splices.

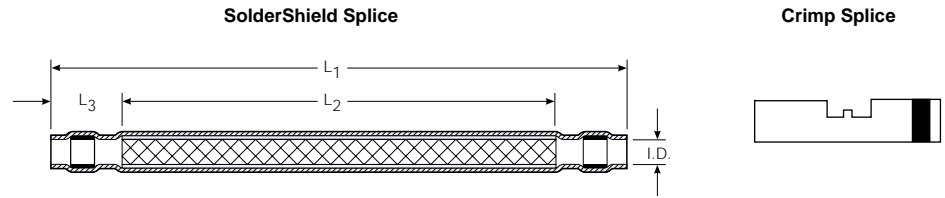

SolderShield Product Dimensions

Part No.		Dimensions				Conductor Splice	Color Code	Quantity Per Kit
Tin Plated	Nickel Plated	L1 Max.	L2 Nom.	L3 Min.	ID Min.	Size Range CMA [mm ²] Min.-Max.		
D-150-0168	D-150-0228	80.50 [3.17]	50.00 [1.97]	10.20 [.400]	3.00 [.118]	304-1510 [0.15-0.75]	Red	1
D-150-0169	D-150-0229	80.50 [3.17]	50.00 [1.97]	10.20 [.400]	4.00 [.157]	779-2680 [0.39-1.34]	Blue	1
D-150-0170	D-150-0230	80.50 [3.17]	50.00 [1.97]	10.20 [.400]	5.00 [.197]	1900-6755 [0.95-3.37]	Yellow	1
D-150-0174	D-150-0231	10.60 [4.17]	75.00 [2.95]	10.20 [.400]	4.00 [.157]	304-1510 [0.15-0.75]	Red	2
D-150-0175	D-150-0232	10.60 [4.17]	75.00 [2.95]	10.20 [.400]	5.00 [.197]	779-2680 [0.39-1.34]	Blue	2
D-150-0176	D-150-0233	10.60 [4.17]	75.00 [2.95]	10.20 [.400]	6.00 [.236]	1900-6755 [0.95-3.37]	Yellow	2
D-150-0177	D-150-0234	10.60 [4.17]	75.00 [2.95]	10.20 [.400]	9.00 [.356]	304-1510 [0.15-0.75]	Red	4
D-150-0178	D-150-0235	10.60 [4.17]	75.00 [2.95]	10.20 [.400]	4.00 [.157]	304-1510 [0.15-0.75]	Red	4
D-150-0179	D-150-0236	10.60 [4.17]	75.00 [2.95]	10.20 [.400]	5.00 [.197]	779-2680 [0.39-1.34]	Blue	4
D-150-0180	D-150-0237	10.60 [4.17]	75.00 [2.95]	10.20 [.400]	6.00 [.236]	1900-6755 [0.95-3.37]	Yellow	4
D-150-0181	D-150-0238	10.60 [4.17]	75.00 [2.95]	10.20 [.400]	9.00 [.353]	1900-6755 [0.95-3.37]	Yellow	4

Note: The SolderShield splice kits listed in this table are for 1:1 cable splices. The kits can be used on cables with tin-, silver-, and nickel-plated copper conductors. All the kits have environmental-sealing capability. The cable temperature rating must be 125°C minimum.

To find the splice kit part number for your application:

1. Determine the number of conductors in the cable to be spliced.
2. Determine the gauge of each conductor or the maximum jacket OD.
3. Determine the conductor plating.
4. Select the appropriate part number from the table above.

SolderShield Shielded and Coaxial Cable Splices (Continued)

Table B. Coaxial Cable Splices

Each SolderShield part consists of a SolderShield splice and one or more conductor splices. Refer to information below for description and numbers of conductor splices.

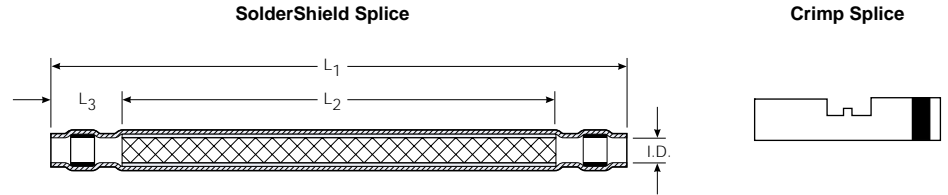

RG Cable No.	Raychem Cable Description	Conductor Splice Qty/Kit	Part No.	SolderShield Dimensions		
				L1 Max	L2 Min	ID Min
8A, 9B, 11	5012A3311					
13, 26, 31	5012E1339					
115, 144, 149	7518A1311	1	D-150-0214	80.50 [3.170]	50.00 [1.970]	12.00 [.472]
165, 213, 214	—					
216, 235, 391	—					
393, 397	—					
178, 196,	5028A1317					
179, 187, 188,	7528A1317					
316, 404, M17/138-00001,	5030A1317	1	D-150-0094	80.50 [3.170]	50.00 [1.970]	3.00 [.118]
M17/136-00001	7530A1317					
180, 195	5024A1311					
M17/137-00001	7526A1311					
M17/139-00001	9527A1318	1	D-150-0095	80.50 [3.170]	50.00 [1.970]	4.00 [.157]
—	9530E1014					
124, 140, 141	5020A1311					
159, 302, 303	5022A1311					
—	7522A1311	1	D-150-0096	80.50 [3.170]	50.00 [1.970]	5.00 [.236]
—	7523D1331					
—	7524A1311					
29, 30, 55B	5019D3318					
58, 223	5021D1331	1	B-202-81*	56.00 [2.200]	23.00 [.900]	7.00 [.275]
—	5022A1311					
59, 62, 71	7523D1331					
—	7524A1311	1	B-202-82*	56.00 [2.200]	23.00 [.900]	7.00 [.275]
—	9524A1311					

*These kits use solder to terminate the center conductors. All other kits use crimp. All kits are for one-to-one coaxial cable splices, and all kits have environmental sealing capability. Each kit contains products to splice conductors, build up dielectric, splice the shield, and provide insulation.

Product Characteristics

Materials		
Insulation sleeve	Radiation-crosslinked polyvinylidene fluoride	
Melttable inserts	Fluorocarbon-based thermoplastic	
MiniSeal crimp splice	Base metal: Copper alloy C10200 per ASTM B75 Plating: Tin per MIL-T-10727 or nickel per QQ-N-290	
SolderShield shield splice	Base metal: Tin-plated copper wire braid per ASTM B3 Solder and flux coating: Type Sn63 Pb37. Flux: ROM1 per ANSI - J - STD - 004 (RA flux)	
Parameter	Test Method	Requirement
Electromechanical Performance		
Dielectric strength (shield connection)	—	No breakdown or arcing at 1000 Vac (RMS)
Dielectric strength (conductor connection)	—	2.5 kV
Voltage drop	MIL-S-81824	Less than 2.0-millivolt increase
Insulation resistance (shield connection)	—	1000 megohms minimum at 500 Vdc
Insulation resistance (conductor connection)	—	5000 megohms
Tensile strength for MiniSeal	MIL-S-81824	Exceed yield strength (pounds) of wire.
Tensile strength for SolderShield	MIL-S-81824	75% of strength (pounds) of unspliced cable
Temperature rating	—	-55°C to 150°C [-67°F to 302°F]
Environmental Resistance		
Salt spray	MIL-STD-202 M101	Meet voltage drop requirement.
Heat aging	750 hours at 150°C [302°F]	Meet all electromechanical requirements.
Temperature cycling	MIL-STD-202 M107C	Meet all electromechanical requirements.
Altitude immersion	Immersion at 22,860m [75,000 ft]	Meet insulation-resistance requirement.
Corrosion resistance	—	No evidence of corrosion after testing in accordance with MIL-STD-202, Method 101, Test Condition A

Holding Fixture Tool AD-1319-9

Product Facts

- AD-1319-9 comes with two lateral wire clamps as standard
- Secures wire or cable, enabling easy installation of products

Applications

Simplifies and speeds installation of Raychem SolderSleeve terminators or splices and SolderTacts shielded contacts.



Specifications and Dimensions

Dimensions	18 cm [7.07 in] W x 15 cm [5.91 in] L
Weight	300 g [.67 lb]

Product Range Covered

SolderSleeve splices	MiniSeal, CWT-9XXX, D-1744, D-110
Shield terminators	D-100-XX
SolderTacts contacts	D-602-XX

Ordering Information

Model	Description	Part No.
Holding fixture	AD-1319-9	993850-000
38999 size 8 SolderTacts adapter	AT-1319-22	395241-000
38999 size 16 SolderTacts adapter	AT-1319-78	413186-000
Submin SolderTacts adapter	AT-1319-12	993872-000
748 SolderTacts adapter	AT-1319-14	993877-000
723 SolderTacts adapter	AT-1319-19	993938-000
482 size 16 SolderTacts adapter	AT-1319-17	993917-000

Note: Additional tooling for SolderTacts can be found under SolderTacts contacts.

Hand-Operated Crimp Tools AD-1377, AD-1522



AD-1377 Crimp Tool

The Raychem AD-1377 crimp tool fits all MiniSeal crimp barrels. It also meets MIL specification M22520/37-01. A calibration verification gauge, AD-1386, is also available for the AD-1377. The gauge meets MIL specification M22520/39-01

AD-1522 Crimp Tool

The Raychem AD-1522 crimp tool crimps all DuraSeal crimp products. It has a preset crimp depth that provides the optimum combination of tensile strength and insulation integrity in the finished splice.

Ordering Information

Model	Description	Part No.
AD-1377 MiniSeal crimp tool	AD-1377-CRIMP-TOOL	992008-000
AD-1386 Calibration gauge	AD-1386-CALIBRATION-GAUGE	992013-000
AD-1522 DuraSeal crimp tool	AD-1522-1-CRIMPING TOOL	047011-000

AD-3050-SEAL-TEST-EQUIP

Seal Test Equipment Splice Sealing and Connector Sealing Evaluation – Various Products

Product Facts

- Simple fixture design allows fast sealing test result assisting determination of installation conditions for splice sealing products
- Connector fixture adapter allows connector sealing verification
- Strong portable container allows use in various locations

**Applications**

The AD-3050-SEAL-TEST-EQUIP is a manually operated pneumatic device, intended for use as a convenient 'in-process' sampling technique for checking sealed splices. Different combinations of in-line or stub splices can be pressure tested in any of the combination of fixtures (8 in total). There is also a facility to allow leak testing of various connectors.

Tyco Electronics UK has seen good correlation between results obtained with the AD-3050 and those obtained through water immersion testing. However testing in accordance with the OEM specification is the only guaranteed way of confirming that the OEM

spec is being met. The splice products are located in clamps which deliver the test pressure. The product is immersed in water and pressure is delivered down the wire(s) to the sealed area. The test result is determined visually by looking for bubbles in the area of the sealing product.

Use of this equipment is described in Tyco Electronics UK procedure, reference No. PIP/017/95. This equipment does not check for poke through i.e. where individual wire strands poke through the installed heat-shrinkable sleeve. Poke through is eliminated by ensuring correct welding and subsequent handling conditions.

Seal Test Equipment Splice
Sealing and Connector
Sealing Evaluation –
Various Products
(Continued)

AD-3050-SEAL-TEST-EQUIP (Continued)

Technical Specification

Pneumatic Supply	6 bar maximum, filtered supply. 2 bar test pressure maximum. (Test pressure typically 0.5 bar)
Machine Cycle Times for seal testing:	Typically 1 minute.
Total System Noise:	Negligible noise from air test
Dimensions:	550 x 350 x 215 [22 x 14 x 8] (Excludes packing case)
Weight:	4 Kg (8.80 lb) (Excludes packing case)
	9.6 Kg (21.20 lb) (Includes packing case)

Ordering Information

	Description	Part No.
Seal Test Equipment	AD-3050-SEAL-TEST-EQUIP	102119-000

Recommended Spares

	Description	Part No.
Tool Assembly	AD-3050-SEAL-TEST-EQUIP	102119-000
Set of 8 Seals**	AD-3050-SEAL-8-KIT	299155-000
Clamp assembly including seals	AD-3050-SEAL-CLAMP-ASSY	168927-000
Sealing tape	EPDM foam, 6 mm x 9 mm, with acrylic adhesive backing.	—

** Full set of seals

Infrared Heating Tool IR-550 Mark II

Product Facts

- Lightweight, portable unit with pedestal base for benchtop operation
- Foot switch, so both hands can be free to hold parts
- Commercially available tungsten-halogen lamp
- Fan-cooled housing
- Instant on/off heat
- Viewing window that allows parts to be inspected during installation
- Quiet, focused IR operation

Applications

Used for installing small and large SolderSleeve devices and SolderTacts contacts.



Specifications

Input power	105–120 V, 50–60 Hz, 4.5 A
Normal lamp life	More than 100 hours of intermittent use
Weight	Approximately 2.5 kg [5.5 lb]
Duty cycle	80%, 90-second max. heating times

Note: For 230V CE-approved version, contact Tyco Electronics.

Ordering Information

Model	Description	Part No.
IR-550 heating tool* (120 V) with RG-2 reflector, viewing window, and foot switch	IR-550-50-MARKII-HT-TOOL	994350-000

Accessories and Replacement Parts

IR-550 foot switch (included with tool assembly 994350)	IR-550-216	994375-000
RG-6 reflector for large-diameter SolderSleeve terminations; aperture is 25.4 mm [1 in. wide]	IR-550-19	994590-000
RG-11 reflector; aperture is 12.7 mm [.5 in.] wide	IR-550-41	993695-000
RG-9 reflector; aperture is 9.525 mm [.375 in.] wide	IR-550-39	993693-000
RG-2 reflector, included with 994350; aperture is 19.05 mm [.75 in.] wide	IR-550-24	993770-000
Lamp (120 V)	IR-1000-P-N-13	993020-000
Optical filter	IR-550-237	118902-000
Viewing window (frame not included)	IR-550-238	007510-000

*IR tools are not recommended for use with black wire or cable insulations.

Infrared Heating Tool IR-1759 MiniRay

Product Facts

- Small, lightweight, fan-cooled unit
- Small profile for installation where space is restricted
- Handheld operation
- Focused heat
- Quiet, efficient IR operation
- CE approved

Applications

Used for installing SolderSleeve devices and SolderTacts contacts.



Specifications and Dimensions

Lamp	Tungsten-halogen Nominal power 250 W, 24 Vac, 50–60 Hz
Fan	12 Vac (supplied through control unit)
Weight	.73 kg [1.6 lb]
Cable length	2 m [6.5 ft]
Electronic Control Unit	
Main supply	110/230 Vac, 50/60 Hz, 11 A/5.5A universal
Weight	3.4 kg [7.6 lb]
Dimensions	16.3 x 12.2 x 12.2 cm [6.4 x 4.8 x 4.8 in.]

Ordering Information

	Description	Part No.
Complete kit consisting of: Handtool/Reflector/Control Box (Dual voltage)	IR1759-MK3-AT3130-EDCont	898738-000

Accessories and Replacement Parts

Handtool, standard aperture	IR-1759-MK3/A	986899-000
Handtool, large aperture	IR-3104-MK3/A	035343-000
Control Box with time control-230 V	ED-7-001-MK2-230V-50HZ	869233-000
Control Box with time control-110 V	ED-7-002-MK2-110V-60HZ	903553-000
Control Box with manual control-110/230V	ED-7-CONT-230/110V	684886-000
Battery Box	ED-7-Batterybox-230/110V	448969-000
Conversion kit (AE-897) for adapting standard-aperture MiniRay heating tool to wide-aperture MiniRay tool (includes reflector)	AT-313/AE-897	934630
Inner reflector (standard aperture)	AE-424	547918-000
Inner reflector (wide aperture)	AE-153	988285-000
Lamp (250 W, 24 V)	NAE-143-3	988208-000
Filter (standard aperture) US	AES-IR1759-100	431468-000 (US only)
Filter (standard aperture) UK	NAE-144-2	988128-000
Filter (wide aperture)	NAE-144-3	988293-000

*IR tools are not recommended for use with black wire or cable insulations.

RBK-ILS-Processor MkII

Installation of Splice Sealing Products Adjacent to Ultrasonic Welder

Product Facts

- Optimized heating element life
- Installation times, temperatures and product size information storage (individual selection)
- Sequenced installations
- Operator key lock/password protection levels
- Automatic heater retraction on mains failure
- Automatic calibration
- RS232 interface allows time, temperature and product sizes for the next installation to be transferred from a remote machine (e.g. an ultrasonic welding tool)
- Machine hours and installation cycle counters
- Software upgradeable to support special applications



Applications

The RBK-ILS-Processor MkII is a semi-automatic unit designed specifically to install splice sealing products onto ultrasonically welded or crimped splice joints used in automotive harnesses.

The tool can operate in several modes:

- Stand-alone — operator sets time and temperature.
- Sequenced — preset times and temperatures can be sequenced automatically (and can also be randomly selected from sequence stored.)
- Automatic — communication with upstream ultrasonic welder can allow time and temperature to be automatically set without operator intervention.

The operator is able to efficiently load both machines and so minimize 'dead time'. Installing Raychem splice sealing products immediately after welding gives reduced installation time and earliest possible mechanical protection for the welded joint. The operator positions the splice sealing product centrally over the splice joint and then locates the assembly into the gripper mechanism.

The wire assembly is automatically ejected, with the splice sealing product installed and the joint area sealed, insulated and strain relieved. In-line or stub-type splices can be installed.

Installation of Splice Sealing Products Adjacent to Ultrasonic Welder

(Continued)

RBK-ILS-Processor MkII (Continued)

Technical Specification

Electrical Supply	220V-240V-50Hz
Power Consumption	1.7 Amps (Max)
Operating Temperature	550°C [1022°F] (Max) (500°C [932°F] recommended)
Machine Cycle Times for splice sealing products used on typical range of automotive splices	6 to 20 seconds depending on wire size and the number of wires used
Total System Noise	<80dB
Dimensions	390 mm x 365 mm x 225 mm [15 x 14 x 9 in.]
Weight	18Kg [40 lb]

Product Range

RBK-ILS-125 Products	Sizes 1 to 3A
RBK-ILS-85 Products	Sizes 6/1 to 12/3
For Other Raychem Products (eg RBK-VWS, RBK-ESS....)	Contact Tyco Electronics

Ordering Information

	Description	Part No.
Equipment	RBK-Proc-Mk2-Processor	740331-000
Accessories	Stub splice fixture - RBK-ILS-Proc-Stub-Sp-Fix	981721-000
	Air cooled stub splice fixture - RBK-ILS-Proc-Air-Cool-Kit	843800-000
	8 mm ring terminal fixture - RBK-ILS-Proc-Termfix-08mm	049857-000

