

OVERVIEW



Overview

Panasonic valve-regulated lead-acid batteries (VRLA battery) have been on the market for more than 30 years. The VRLA battery is a rechargeable battery which does not require adding water. Based on AGM (Absorbed Glass Mat) technology with calcium grids, the batteries offer excellent high rate performance characteristics and increased life expectancy.

Our cumulative technological know-how has enabled us to respond to market requirements promptly by developing batteries such as trickle/cycle long life type and improving charging capabilities to allow for quick charging in 1 to 2 hours. The VRLA battery covers a broad range of applications including, electric tools, UPS, emergency lighting and electric wheel chairs.

Battery Types and model numbers

For main power applications — Cycle long life typeLC-XC

For main and standby power applications — Expected trickle life 3-5(approx. 5*) years..LC-R

For standby power applications — [Expected trickle life 3-5 (approx.5*) years...UP-RW
Expected trickle life approx. 6(10) years* [Standard caseLC-X
Flame-retardant case ..LC-P

Expected trickle life: Up to 50% of initial capacity under the following conditions:

Temperature: 77°F (25°C)

Discharge current: 0.25CA

Discharge ending voltage: 5.25V for 6V battery, 10.5V for 12V battery

Charge voltage: 6.85V for 6V battery, 13.7V for 12V battery

*Approximately 6 years at 20°C, 0.1C

GENERAL INFORMATION ON VALVE-REGULATED LEAD-ACID BATTERIES

Construction and Electrolyte

- **Positive plates**

Positive plates are plate electrodes of which a grid frame of lead-tin-calcium alloy holds porous lead dioxide as the active material.

- **Negative plates**

Negative plates are plate electrodes of which a grid frame of lead-tin-calcium alloy holds spongy lead as the active material.

- **Electrolyte**

Diluted sulfuric acid is used as the medium for conducting ions in the electrochemical reaction in the battery.

- **Separators**

The advanced micro porous Absorbed Glass Mat (AGM) separators retain electrolyte and prevent shorting between positive and negative plates. Separators adopt a non-woven fabric of fine glass fibers which is chemically stable in the diluted sulfuric acid electrolyte. Being highly porous, separators retain electrolyte for the reaction of active materials in the plates.

- **Valve (One way valve)**

The valve is comprised of a one-way valve made of material such as neoprene. When gas is generated in the battery under extreme overcharge conditions due to erroneous charging, charger malfunctions or other abnormalities, the vent valve opens to release excessive pressure in the battery and maintain the gas pressure within specific range (7.1 to 43.6 kPa). "The vent helps protect the battery from the danger of bursting. Since the rubber valve is instantly resealable, the valve can perform this function repeatedly whenever required."

- **Example of Valve Construction**

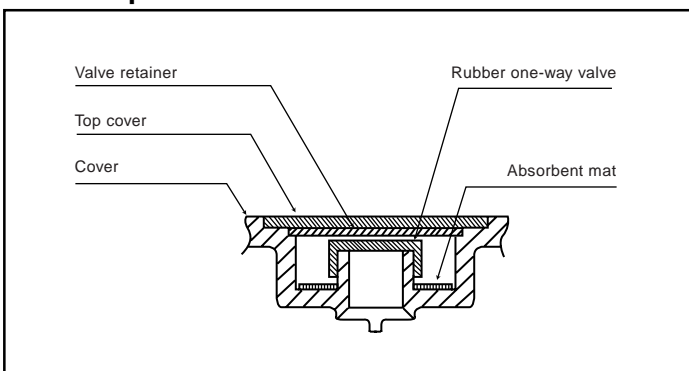

During ordinary use of the battery, the vent valve is closed to shut out outside air and prevent oxygen in the air from reacting with the active material in the negative electrodes.

- **Positive and negative electrode terminals**

Positive and negative electrode terminals may be faston tab type, bolt fastening type, threaded post type, or lead wire type, depending on the type of the battery. Sealing of the terminal is achieved by a structure which secures long adhesive-embedded paths and by the adoption of strong epoxy adhesives. For specific dimensions and shapes of terminals, refer to the terminal dimensions page in the back of the technical handbook.

- **Battery case materials**

Materials of the body and cover of the battery case are ABS resins, unless otherwise specified.

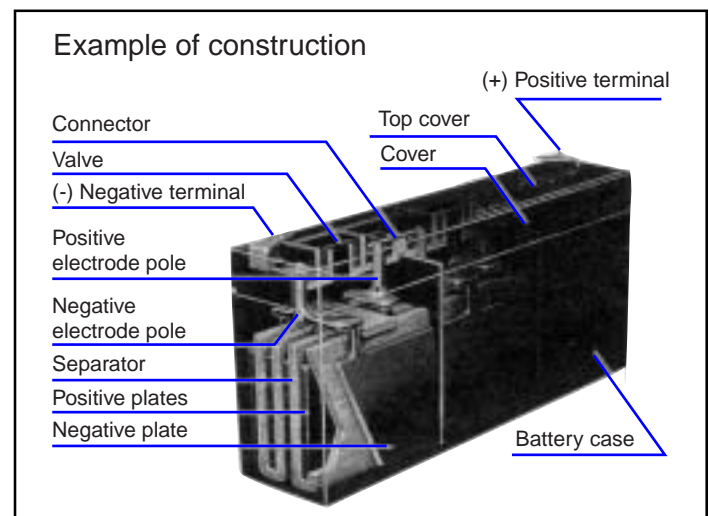

GENERAL INFORMATION ON VALVE-REGULATED LEAD-ACID BATTERIES - CONT.

Electrochemical Reactions on Electrodes

The electrochemical reaction processes of the valve-regulated lead-acid battery (negative electrode recombination type) are described below. Where "charge" is the operation of supplying the rechargeable battery with direct current from an external power source to change the active material

in the negative plates chemically, and hence to store in the battery electric energy in the form of chemical energy. "Discharge" is the operation of drawing out electric energy from the battery to operate external equipment.

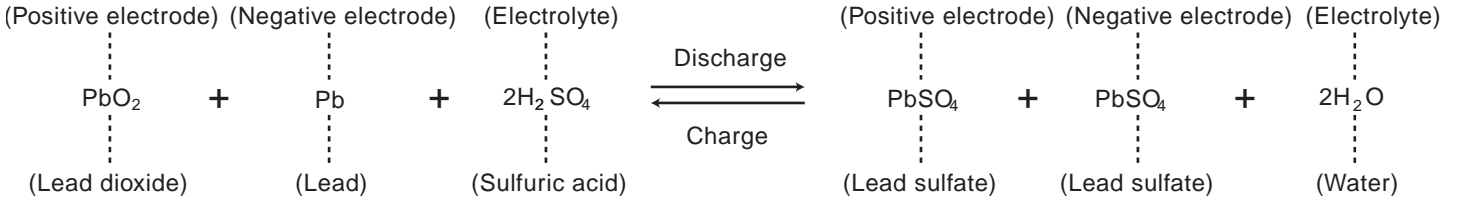

In the final stage of charging, an oxygen-generating reaction occurs at the positive plates. This oxygen transfers inside the battery, then is absorbed into the

surface of the negative plates and consumed. These electrochemical reaction processes are expressed as follows.

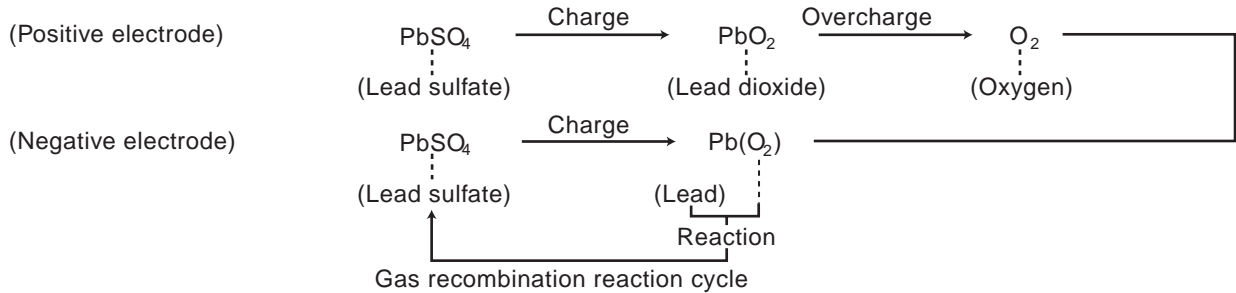

Applications

- **Stand-by/Back-up power applications**
 - Communication equipment: base station, PBX, CATV, WLL, ONU, STB, etc.
 - Back-up for power failure: UPS, ECR, computer system back-up, sequencers, etc.
 - Emergency equipment: lights, fire and burglar alarms, radios, fire shutters, stop-position controls (for machines and elevators), etc.
- **Main power applications**
 - Communication equipment: transceivers
 - Electrically operated vehicles: picking carts, automated transports, electric wheelchairs, cleaning robots, electric automobiles, etc.
 - Tools and engine starters: grass shears, hedge trimmers, cordless drills, screwdrivers, jet-skis, electric saws, etc.
 - Industrial equipment/instruments and non life-critical medical equipment*: measuring equipment, non life-critical medical equipment (electrocardio-graph), etc.
 - Photography: camera strobes, VTR/VCR, movie lights, etc.
 - Toys and hobby: radio-controllers, motor drives, lights, etc.
 - Miscellaneous uses: integrated VTR/VCR, tape recorders, other portable equipment, etc.

*(Note) When any medical equipment incorporating a Panasonic VRLA battery is planned, please contact Panasonic.

Features

● Leak-resistant structure

A required-minimum quantity of electrolyte is impregnated into, and retained by, the positive and negative plates and the separators; therefore electrolyte does not flow freely. Also, the terminal has a sealed structure secured by long adhesive-embedded paths and by the adoption of strong epoxy adhesives which makes the battery leak-resistant.

(Note) In stand-by/back-up uses, if the battery continues to be used beyond the point where discharge duration has decreased to 50% of the initial (i.e. life judgment criteria), cracking of the battery case may occur, resulting in leakage of the electrolyte.

● Long service life

Service life of our long-life series (LC-P, LC-X series) is approximately double that of the conventional LC-R series batteries (Temperature 25°C, discharge rate 0.25 CA/ 1.75V/cell, discharge frequency every 6 months, 2.30V/cell charge).

● Easy maintenance

Unlike the conventional batteries in which electrolyte can flow freely, VRLA batteries do not need specific-gravity checks of the electrolyte nor do they need to have water added; This makes the battery function fully and makes maintenance easy.

● No sulfuric acid mist or gases

Unlike the conventional batteries in which electrolyte can flow freely, VRLA batteries generate no sulfuric acid mist or gases under the use condition we recommend. In uses under conditions other than recommended, however, gas generation may occur, therefore do not design the battery housing with a closed structure.

● Exceptional deep discharge recovery

As seen in the figure on the next page, our VRLA battery shows exceptional rechargeability even after deep discharge, which is often caused by failure to turn off the equipment switch, followed by standing (approx. 1 month at room temperature is assumed).

GENERAL INFORMATION ON VALVE-REGULATED LEAD-ACID BATTERIES - CONT.

Example of rechargability after deep discharge and standing

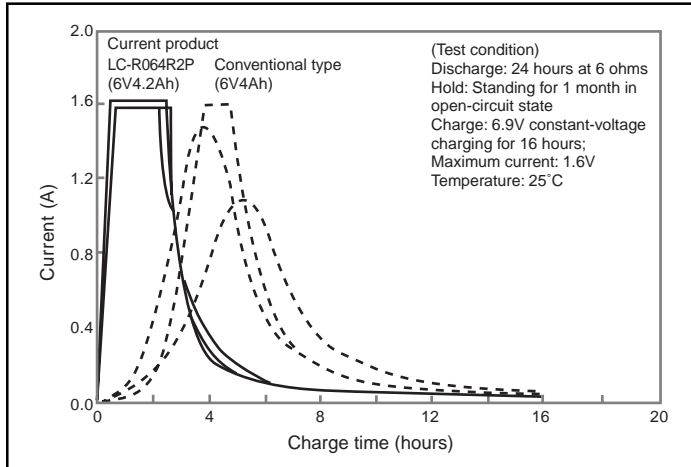

Transportation

All of our lead acid batteries are unregulated by DOT for transportation by truck, rail, ocean and air transportation because they meet the requirements of 49 CFR 173.159 (d). The only transportation requirements are:

- 1) The battery must be securely packaged in such a way to prevent the possibility of short circuiting.
- 2) The battery and the outer most packaging must be labeled "NONSPILLABLE" or "NONSPILLABLE BATTERY".

All of our lead acid batteries are unregulated for air transportation because they meet the requirements of Special Provision--"A67" as promulgated by the International Air Transportation Association (IATA) and the International Civil Aviation Organization (ICAO). They also meet the Vibration and Pressure Differential

Tests of the International Maritime Dangerous Goods (IMDG) regulations.

• ISO 9001

The quality systems at our Hamanako plant (Japan) have been recognized and registered by the Quality Assurance Corporate Registration System as conforming with ISO 9001.

• ISO 9002

The quality systems at our SLMB (China) and MBIA (Mexico) have been recognized and registered by the Quality Assurance Corporate Registration System as conforming with ISO 9002.

• ISO 14001

The Environmental Management Systems at our SLMB (China) plant has been approved with the ISO 14001.

• JIS (Japan Industrial Standards)

Our sealed lead-acid batteries comply with JIS C 8702.

• UL recognition

Our VRLA batteries fall into UL1989 (Standby Batteries). UL1989 requires that the battery is free from the hazard of bursting, that is, when the battery is overcharged the vent valve opens to release internal pressure. UL-recognized types of VRLA batteries to date are listed in the following table. A number of the recognized battery types are in use for such applications as emergency lights.

• VDE and other recognition

The types of VRLA batteries which have acquired VDE (Germany) recognition are also listed.

Table of battery types which acquired local/overseas recognition

Standard/recognition	Contents	Recognition number	Recognized Models
UL U.S. Safety standard	U.L. 1989 Standby Batteries	MH13723	LC-R061R3(a) LC-R063R4(a) LC-R064R2(a) LC-R067R2(a) LC-R0612(a) LC-R121R3(a) LC-R122R2(a) LC-R123R4(a) LC-R127R2(a) LC-RA1212P LC-RD1217(a) LC-LA1233(a) LC-SD122(a) LC-SA122R3(a) LC-V067R2(a) LC-V0612(a) LC-V121R3(a) LC-V122R2(a) LC-V123R4(a) LC-V127R2(a) LC-V1212 LC-VD1217(a) LC-VA1233(a) LC-T122(a) LC-TA122(a) LC-P067R2(a) LC-P0612(a) LC-P127R2(a)
VDE German Safety Standard		G196049 G188151 G191053 G198048 G193046 G100001 G198049 B100002 G199090	LC-121R3PG LC-R127P/P1 LC-X1224APG/AP LC-R122R2PG LC-R127R2PG/PG1 LC-X1238APG/AP LC-R123R4PG LC-RA1212PG/PG1 LC-RA1212P/P1 LC-X1265PG/P

Additional configuration codes (alphabetic letters or numbers) may appear for (a) in the code numbers of UL recognized types. (Note) These standards are also valid for old model numbers.

CHARACTERISTICS

• Charging

Charge characteristics (constant voltage-constant current charging) of VRLA batteries are exemplified below.

Example of constant-voltage charge characteristics by current

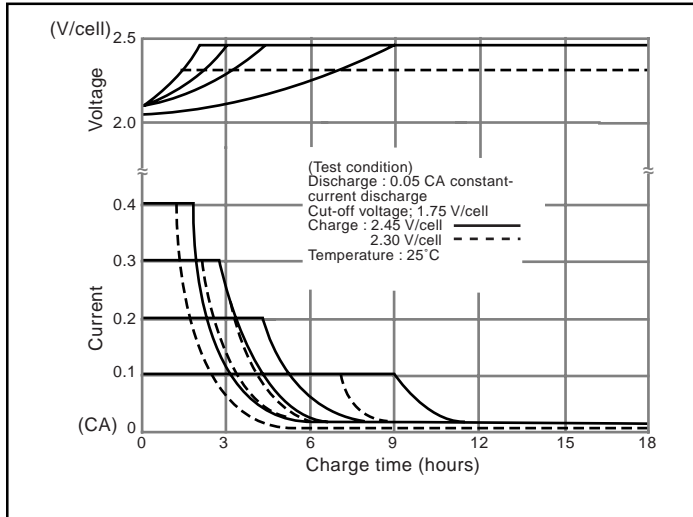

In order to fully utilize the characteristics of VRLA batteries, constant-voltage charging is recommended. For details of charging see page 20.

• Discharging

a) Discharge current and discharge cut-off voltage Recommended cut-off voltages for 6V and 12V batteries consistent with discharge rates are given in the figure below. With smaller discharge currents, the active materials in the battery work effectively, therefore discharge cut-off voltages are set to the higher side for controlling overdischarge. For larger discharge currents, on the contrary, cut-off voltages are set to the lower side. (Note) Discharge cut-off voltages given are recommended values.

Discharge current vs. Cut-off voltage

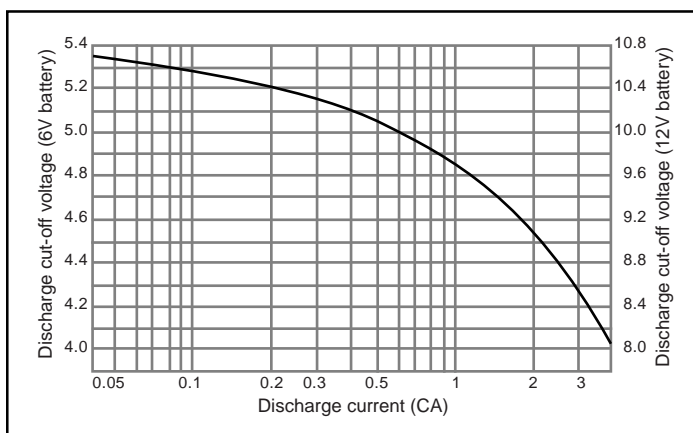

b) Discharge temperature

(1) Control the ambient temperature during discharge within the range from 5°F-122°F (-15°C to 50°C) for the reason described below.

(2) Batteries operate on electrochemical reaction which converts chemical energy to electric energy. The electrochemical reaction is reduced as the temperature lowers, thus, available discharge capacity is greatly reduced at temperatures as low as -5°F (-15°C). For the high temperature side, on the other hand, the discharge temperature should not exceed 122°F (50°C) in order to prevent deformation of resin materials which house the battery or deterioration of service life.

c) Effect of temperature on discharge characteristics

Available discharge capacity of the battery varies with ambient temperature and discharge current as shown in the figure below.

Discharge capacity by temperature and by discharge current

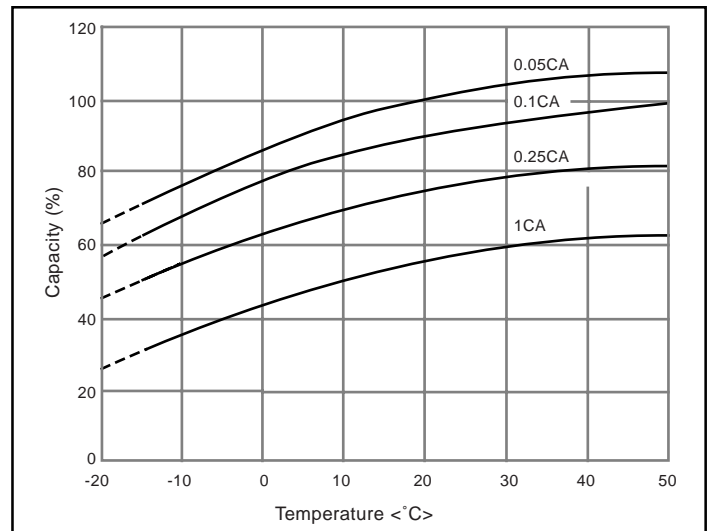

CHARACTERISTICS - CONTINUED

d) Discharge current

Discharge capability of batteries is expressed by the 20 hour rate (rated capacity). Select the battery for specific equipment so that the discharge current during use of the equipment falls within the range between 1/20 of the 20 hour rate value and 3 times that (1/20 CA to 3 CA): discharging beyond this range may result in a marked decrease of discharge capacity or reduction in the number of times of repeatable discharge. When discharging the battery beyond said range, please consult Panasonic in advance.

(Note) With some types of VRLA batteries which have a built-in thermostat, the thermostat may automatically cut off the circuit when discharge current exceeds 4 A at the ambient temperature of 104°F (40°C); therefore, the maximum discharge current value should be the smaller one of either 4 A or 2 CA.

e) Depth of discharge

Depth of discharge is the state of discharge of batteries expressed by the ratio of amount of capacity discharged to the rated capacity.

• Storage

a) Storage condition

Observe the following condition when the battery needs to be stored.

- (1) Ambient temperature: 5°F to 104°F (-15°C to 40°C) (preferably below 86°F (30°C))
- (2) Relative humidity: 25 to 85%
- (3) Storage place free from vibration, dust, direct sunlight, and moisture.

b) Self discharge and refresh charge

During storage, batteries gradually lose their capacity due to self discharge, therefore the capacity after storage is lower than the initial capacity. For the recovery of capacity, repeat charge/discharge several times for the battery in cycle use; for the battery in trickle use, continue charging the battery as loaded in the equipment for 48 to 72 hours.

c) Refresh charge (Auxiliary charge)

When it is unavoidable to store the battery for 3 months or longer, periodically recharge the battery at the intervals recommended in the table below depending on ambient temperature. Avoid storing the battery for more than 12 months.

Storage temperature	Interval of auxiliary charge (refresh charge)
Below 68°F (20°C)	9 months
68°F (20°C) to 86°F (30°C)	6 months
86°F (30°C) to 104°F (40°C)	3 months

d) Residual capacity after storage

The result of testing the residual capacity of the battery which, after fully charged, has been left standing in the open-circuit state for a specific period at a specific ambient temperature is shown in the figure below. The self discharge rate is very much dependent on the ambient temperature of storage. The higher the ambient temperature, the less the residual capacity after storage for a specific period. The self discharge rate almost doubles by each 10°C rise of storage temperature.

Residual capacity test result

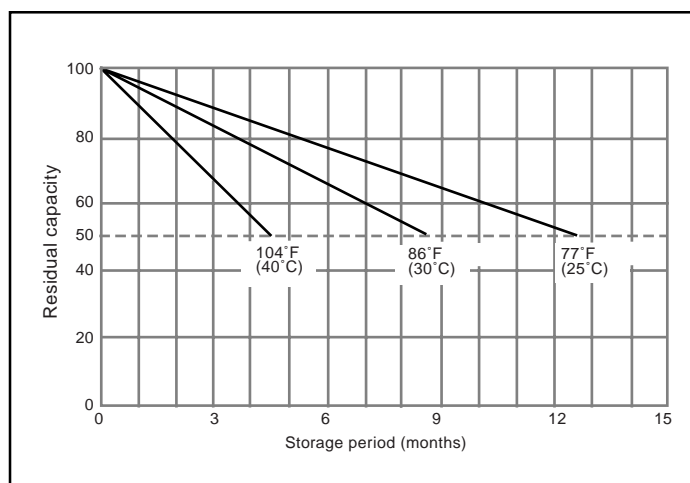

CHARACTERISTICS - CONTINUED

e) Open circuit voltage vs. residual capacity

Residual capacity of the battery can be roughly estimated by measuring the open circuit voltage as shown in the Figure.

Open circuit voltage vs. Residual capacity 77°F (25°C)

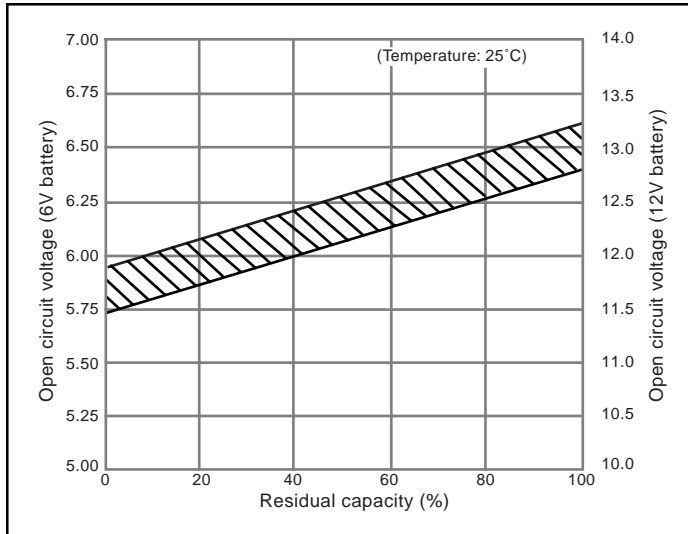

- Temperature conditions**

Recommended temperature ranges for charging, discharging and storing the battery are tabulated below.

Charge	32°F (0°C) ~ 104°F (40°C)
Discharge	5°F (-15°C) ~ 122°F (50°C)
Storage	5°F (-15°C) ~ 104°F (40°C)

- Battery life**

a) Cycle life

Cycle life (number of cycles) of the battery is dependent on the depth of discharge in each cycle. The deeper the discharge is, the shorter the cycle life (smaller number of cycles), providing the same discharge current. The cycle life (number of cycles) of the battery is also related to such factors as the type of the battery, charge method, ambient temperature, and rest period between charge and discharge. Typical cycle-life characteristics of the battery by different charge/discharge conditions are shown by the chart to the right.

This data is typical and tested at a well-equipped laboratory in a controlled environment.

Cycle times are different for each battery model.

Cycle times can also differ from this data when using batteries under real conditions.

Cycle life vs. Depth of discharge

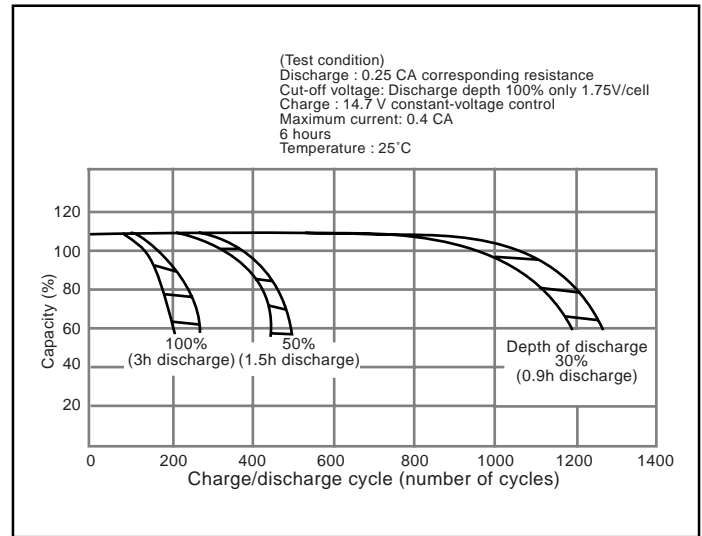

CHARACTERISTICS - CONTINUED

b) Trickle (Float) life

Trickle life of the battery is largely dependent on the temperature condition of the equipment in which the battery is used, and also related to the type of the battery, charge voltage and discharge current. The respective Figures show the influence of temperature on trickle life of the battery, an example of trickle (float) life characteristics of the battery, and the test result of the battery life in an emergency lamp.

Influence of Temperature on Trickle life

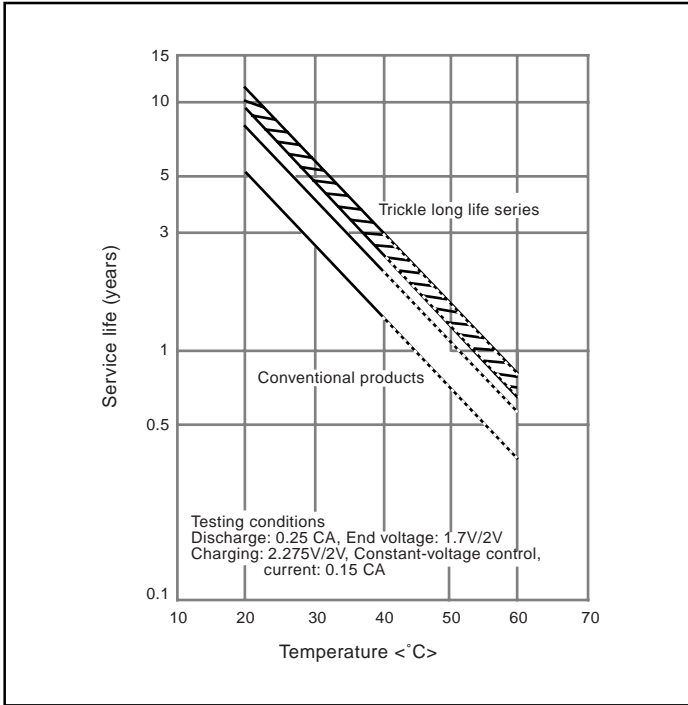

Trickle (Float) life characteristics (LC-R and LC-L)

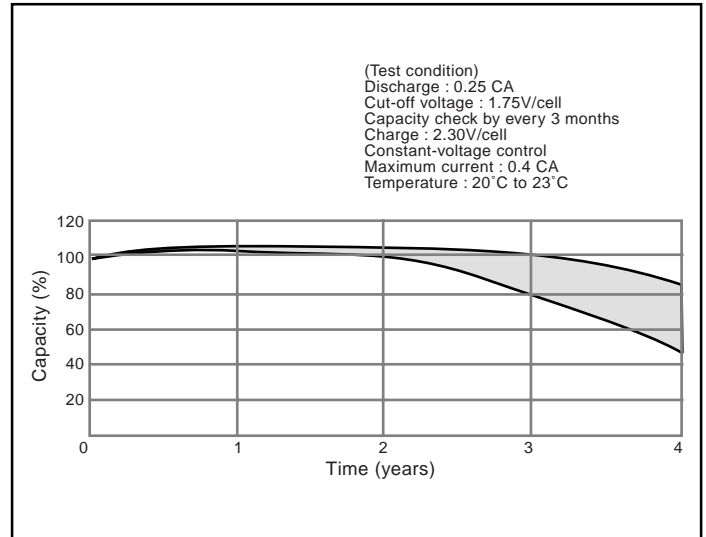

Trickle life characteristics at 122°F (50°C)

